

TABLE OF CONTENTS

Cha/Sec/Sub	<u>Title</u>	<u>Pages</u>
	TABLE OF CONTENTS	1-6
	INTRODUCTION	1-8
	LIST OF EFFECTIVE CHAPTERS	1-2
04	AIRWORTHINESS LIMITATIONS	
04-00-00	Airworthiness Limitations - General	1-2
05	TIME LIMITS / MAINTENANCE CHECKS	
05-00-00	Time Limits / Maintenance Checks - General	1
05-10-00	Component Time Limits	1-3
05-20-00	Scheduled Maintenance Checks	1-15
05-30-00	Daily Inspections	1
05-50-00	Unscheduled Maintenance Checks	1-2
06	DIMENSIONS AND AREAS	
06-00-00	Dimensions and Areas - General	1
06-10-00	Aircraft Dimensions and Areas	1-3
06-20-00	Aircraft Zoning	1-2
06-30-00	Access/Inspection Plates	1-2
07	LIFTING AND SHORING	
07-00-00	Lifting and Shoring - General	1
07-10-00	Jacking	201-202
08	LEVELING AND WEIGHING	
08-00-00	Leveling and Weighing - General	1
08-10-00	Weighing	201-203
08-20-00	Leveling	201-202
09	TOWING AND TAXIING	
09-00-00	Towing and Taxiing - General	1
09-10-00	Towing	201-202
09-20-00	Taxiing	201
10	PARKING, MOORING, STORAGE AND RETURN TO SERVICE	
10-00-00	Parking, Mooring, Storage and Return to Service - General	1
10-10-00	Parking	201
10-11-00	Storage	201-202
10-20-00	Mooring	201
10-30-00	Return to Service	201

TABLE OF CONTENTS (Cont.)

Cha/Sec/Sub	<u>Title</u>	<u>Pages</u>
11	PLACARDS AND MARKINGS	
11-00-00	Placards and Markings - General	1
11-20-00	Exterior Placards and Markings	201-206
11-30-00	Interior Placards and Markings	201-208
12	SERVICING	
12-00-00	Servicing - General	1
12-10-00	Replenishing - Description	1-2
12-11-00	Fuel - Servicing	301-302
12-12-00	Engine Oil - Servicing	301-302
12-13-00	Induction Air Filter - Servicing	301
12-14-00	Cooling System - Servicing	301-302
12-15-00	Brake System - Servicing	301
12-16-00	Tires - Servicing	301
12-17-00	Battery - Servicing	301
12-20-00	Scheduled Servicing - Description	1
12-21-00	Lubricants - Description	1-2
12-22-00	Lubrication - Servicing	301-303
12-23-00	Aircraft Exterior - Cleaning and Care	701-704
12-24-00	Aircraft Interior - Cleaning and Care	701-702
12-30-00	Unscheduled Servicing	301
20	STANDARD PRACTICES AIRFRAME	
20-00-00	Standard Practices Airframe - General	1
20-10-00	Fastener Identification and Torque Data	1-4
20-11-00	Conversion Data	1-3
21	VENTILATION AND HEATING	
21-00-00	Ventilation and Heating - General	1
21-20-00	Fresh Air Distribution - Description	1
21-20-00	Fresh Air Distribution - Maintenance	201
21-40-00	Heating - Maintenance	201
23	COMMUNICATIONS	
23-00-00	Communications - General	1
23-10-00	Speech Communication - Description	1-2/2/2 ¹⁾
23-10-00	Speech Communication - Maintenance	201-202/202/202 ¹⁾
23-50-00	Audio Integrating - Maintenance	201-202/202 ¹⁾
24	ELECTRICAL POWER	
24-00-00	Electrical Power - General	1
24-00-00	Electrical Power - Troubleshooting	101-102
24-20-00	Alternator System - Description	1-2
24-20-00	Alternator System - Maintenance	201-204

¹⁾ Depending on effectivity.

TABLE OF CONTENTS (Cont.)

<u>Cha/Sec/Sub</u>	<u>Title</u>	<u>Pages</u>
24-30-00	Battery System - Description	1-2
24-30-00	Battery System - Maintenance	201-202
24-40-00	External Power - Maintenance	201-203
24-60-00	Electrical Load Distribution - Description	1
24-61-00	Circuit Breaker - Maintenance	201
24-97-00	Electrical System Wiring - Maintenance	201
25	EQUIPMENT / FURNISHINGS	
25-00-00	Equipment / Furnishings - General	1
25-10-00	Seats - Maintenance	201-203
25-11-00	Restraint System - Maintenance	201
25-12-00	Cabin Interior - Maintenance	201-203
25-50-00	Cargo Tie Downs - Maintenance	201
25-60-00	Emergency Equipment - Description	1-2
25-62-00	Emergency Locator Transmitter - Maintenance	201-202
25-66-00	Fire Extinguisher - Maintenance	201-201/202 ¹⁾
27	FLIGHT CONTROLS	
27-00-00	Flight Controls - General	1
27-10-00	Aileron Control System - Description	1-2
27-10-00	Aileron Control System - Maintenance	201-207
27-20-00	Rudder Control System - Description	1-2
27-20-00	Rudder Control System - Maintenance	201-205
27-30-00	Elevator Control System - Description	1-2
27-30-00	Elevator Control System - Maintenance	201-205
27-31-00	Elevator Trim Control System - Description	1-2
27-31-00	Elevator Trim Control System - Maintenance	201-202
27-50-00	Flap Control System - Description	1-2
27-50-00	Flap Control System - Maintenance	201-205
28	FUEL	
28-00-00	Fuel - General	1-2
28-10-00	Fuel Storage - Maintenance	201
28-20-00	Fuel Distribution - Maintenance	201-205
28-41-00	Fuel Quantity Indication - Maintenance	201-206
31	INDICATING / RECORDING SYSTEMS	
31-00-00	Indicating / Recording Systems - General	1-2/2/2 ¹⁾
31-10-00	Instrument Panel - Maintenance	201-202
31-30-00	Recorders - Maintenance	201-204

¹⁾ Depending on effectivity.

TABLE OF CONTENTS (Cont.)

Cha/Sec/Sub	<u>Title</u>	<u>Pages</u>
32	LANDING GEAR	
32-00-00	Landing Gear - General	1
32-10-00	Main Gear - Description	1
32-10-00	Main Gear - Maintenance	201-202
32-20-00	Nose Gear - Description	1
32-20-00	Nose Gear - Maintenance	201-203
32-40-00	Wheels and Brakes - Description	1
32-40-00	Wheels and Brakes - Maintenance	201-208
33	LIGHTS	
33-00-00	Lights - General	1
33-10-00	Interior Lights - Maintenance	201-202
33-40-00	Exterior Lights - Maintenance	201-203/202 ¹⁾
34	NAVIGATION	
34-00-00	Navigation - General	1
34-11-00	Pitot / Static System - Description	1-2
34-11-00	Pitot / Static System - Maintenance	201-204
34-18-00	Stall Warning System - Description	1
34-18-00	Stall Warning System - Maintenance	201
34-20-00	Attitude and Direction - Maintenance	201-203
34-25-00	Integrated Flight System - Maintenance	201-204/205 ¹⁾
34-40-00	Independent Position Determining - Maintenance	201-201/202/205 ¹⁾
34-45-00	Collision Warning System - Maintenance	201-204
34-50-00	Dependent Position Determining - Maintenance	201-202/203 ¹⁾
51	STRUCTURES	
51-00-00	Structures - General	1-2
51-10-00	Composite Damage Investigation	201-203
51-20-00	Composite Repair	201-223
52	DOORS	
52-00-00	Doors - General	1
52-10-00	Canopy - Maintenance	201-204
52-30-00	Baggage Door - Maintenance	201
53	FUSELAGE	
53-00-00	Fuselage - General	1
53-10-00	Fuselage Main Frame - Description	1-4
53-10-00	Fuselage Main Frame - Maintenance	201
53-20-00	Auxiliary Structure - Description	1

¹⁾ Depending on effectivity.

TABLE OF CONTENTS (Cont.)

<u>Cha/Sec/Sub</u>	<u>Title</u>	<u>Pages</u>
55	STABILIZERS	
55-00-00	Stabilizers - General	1
55-10-00	Horizontal Stabilizer - Maintenance	201
55-20-00	Elevator - Maintenance	201-203
55-30-00	Vertical Stabilizer - Maintenance	201
55-40-00	Rudder - Maintenance	201-202
56	WINDOWS	
56-00-00	Windows - General	1
56-10-00	Flight Compartment Windows - Maintenance	201-203
57	WINGS	
57-00-00	Wings - General	1
57-10-00	Wing - Maintenance	201-206
57-50-00	Control Surfaces - Maintenance	201-207
61	PROPELLER	
61-00-00	Propeller - General	1
61-00-00	Propeller - Troubleshooting	101-103
61-10-00	Propeller Assembly - Maintenance	201-204
61-20-00	Propeller Control - Maintenance	201-204/204/204 ¹⁾
71	POWER PLANT	
71-00-00	Power Plant - General	1
71-00-01	Engine - Description	1-3
71-00-01	Troubleshooting - Rotax 912S	101-104
71-00-01	Rotax 912S - Maintenance	201-203
71-10-00	Cowling - Maintenance	201-202
71-20-00	Engine Mount - Maintenance	201
71-60-00	Air Induction System - Maintenance	201
74	IGNITION SYSTEM	
74-00-00	Ignition System - General	1-2
74-10-00	Ignition System - Maintenance	201-203
75	COOLING SYSTEM	
75-00-00	Cooling System - General	1-2
75-10-00	Cooling System - Maintenance	201-202
75-10-01	Winterization Kit - Maintenance	201-202
76	ENGINE CONTROLS	
76-00-00	Engine Controls - General	1
76-00-00	Engine Controls - Maintenance	201-205

¹⁾ Depending on effectivity.

TABLE OF CONTENTS (Cont.)

<u>Cha/Sec/Sub</u>	<u>Title</u>	<u>Pages</u>
77	ENGINE INDICATING	
77-00-00	Engine Indicating - General	1
77-10-00	Power Indication - Maintenance	201-202
77-20-00	Temperature Indication - Maintenance	201
78	EXHAUST	
78-00-00	Exhaust - General	1
78-10-00	Exhaust - Maintenance	201-202
79	OIL	
79-00-00	Oil - General	1-2
79-10-00	Oil Tank - Maintenance	201-202
79-20-00	Oil Cooler - Maintenance	201
79-30-00	Oil Temperature Measuring System - Maintenance	201
79-31-00	Oil Pressure Measuring System - Maintenance	201
80	STARTING	
80-00-00	Starting - General	1
80-10-00	Starter - Maintenance	1
91	CHARTS AND DIAGRAMS	
91-00-00	Charts and Diagrams - General	1-24

RECORD OF REVISIONS

Revision Number	Date of Revision	Date Inserted	By	Revision Number	Date of Revision	Date Inserted	By
1	01.10.01			26	02.03.15		
2	29.10.01			27	21.07.15		
3	05.11.01			28	28.08.15		
4	07.11.01			29	29.02.16		
5	26.11.01						
6	01.03.02						
7	15.03.02						
8	22.03.02						
9	14.05.02						
10	18.05.02						
11	08.07.02						
12	26.04.05						
13	28.10.05						
14	18.01.06						
15	30.04.08						
16	15.09.09						
17	02.03.10						
18	21.06.10						
19	25.11.10						
20	24.02.11						
21	05.11.12						
22	19.03.13						
23	19.07.13						
24	15.08.13						
25	30.10.13						

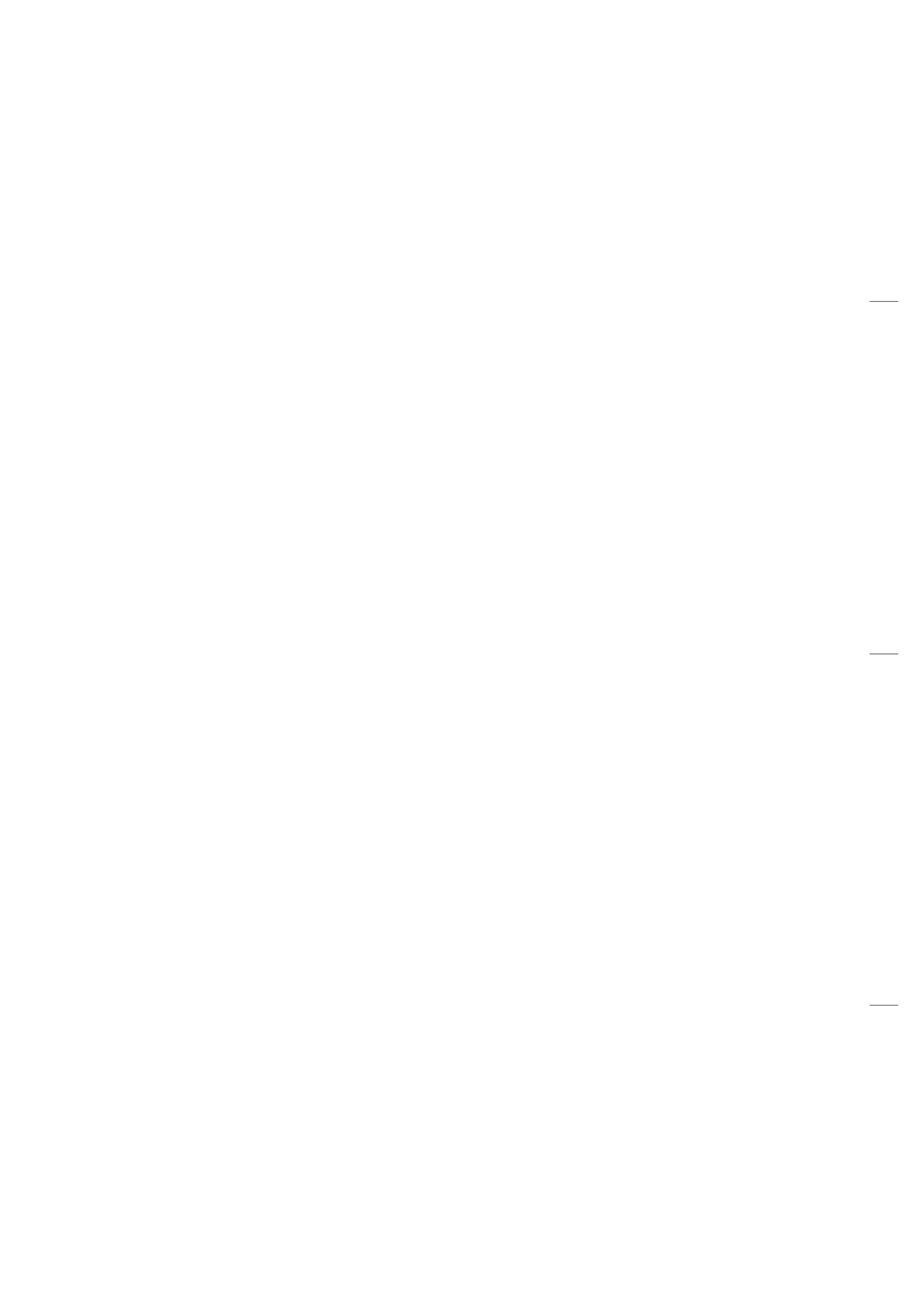

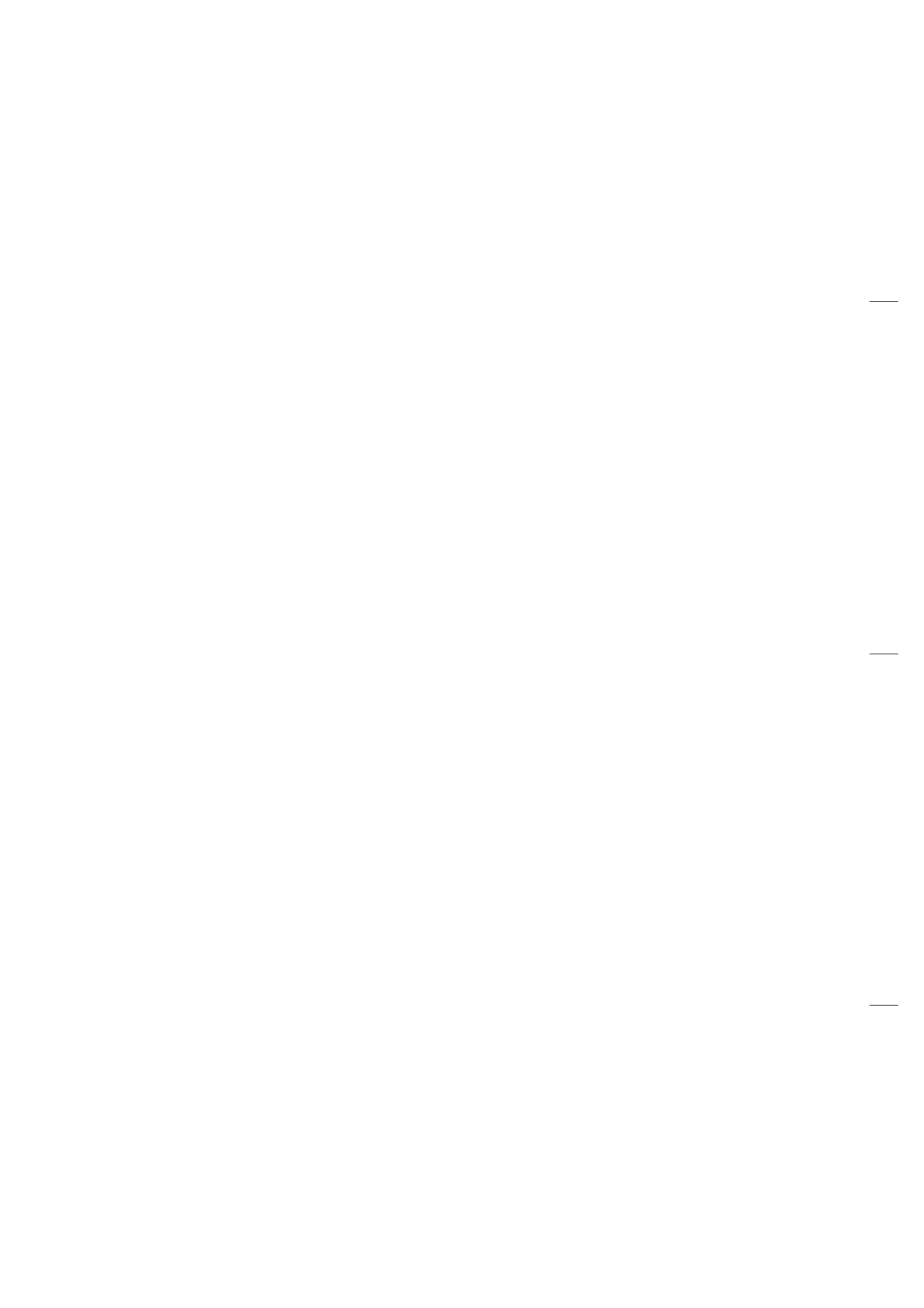

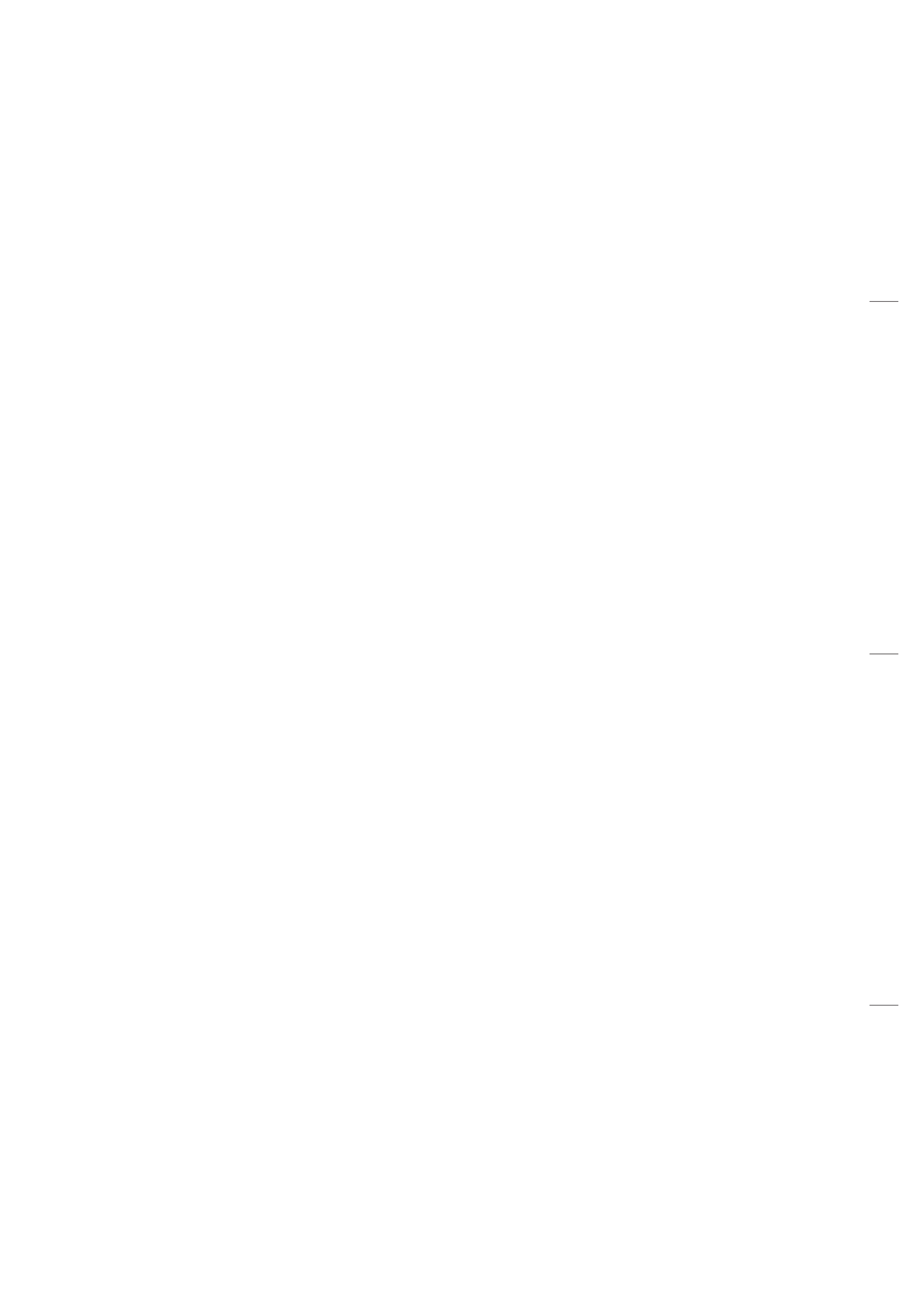

LIST OF EFFECTIVE CHAPTERS

Chapter Title	Date*
GENERAL	
Table of Contents	29.02.16
Introduction	30.10.13
04 Airworthiness Limitations	02.03.15
05 Time Limits / Maintenance Checks	28.08.15
06 Dimensions and Areas	26.04.05
07 Lifting & Shoring	30.10.13
08 Leveling and Weighing	27.09.01
09 Towing and Taxiing	02.03.10
10 Parking, Mooring, Storage & Return to Service	02.03.10
11 Placards and Markings	05.11.12
12 Servicing	30.10.13
 AIRFRAME SYSTEMS	
20 Standard Practices Airframe	05.11.12
21 Ventilation and Heating	08.07.02
23 Communications	30.10.13
24 Electrical Power	30.10.13
25 Equipment and Furnishings	30.10.13
27 Flight Controls	30.10.13
28 Fuel	21.07.15
31 Indicating/Recording Systems	30.10.13
32 Landing Gear	15.03.02
33 Lights	30.10.13
34 Navigation	30.10.13
 STRUCTURES	
51 Structures	29.02.16
52 Doors	30.10.13
53 Fuselage	30.10.13
55 Stabilizers	14.05.02
56 Windows	19.07.13
57 Wings	18.01.06
 PROPELLER	
61 Propeller	19.03.13

LIST OF EFFECTIVE CHAPTERS

Chapter Title	Date*
POWER PLANT	
71 Power Plant	26.04.05
74 Ignition	29.10.01
75 Cooling System	26.04.05
76 Engine Controls	28.08.15
77 Engine Indicating	26.11.01
78 Exhaust	07.11.01
79 Oil	07.11.01
80 Starting	05.11.01
91 Charts and Wiring Diagrams	30.04.08

* The date refers to the issue / revision date of the respective chapter.

The technical content of this document (revision 29) is approved under the authority of
DOA ref. EASA.211.025.

29.02.2016
Date, Signature Office of Airworthiness

A circular blue stamp with the Aquila logo and the text 'AQUILA Head of Airworthiness'. A handwritten signature in blue ink is written over the stamp.



**AQUILA AT01
MAINTENANCE MANUAL**

**CHAPTER 51
STRUCTURES**

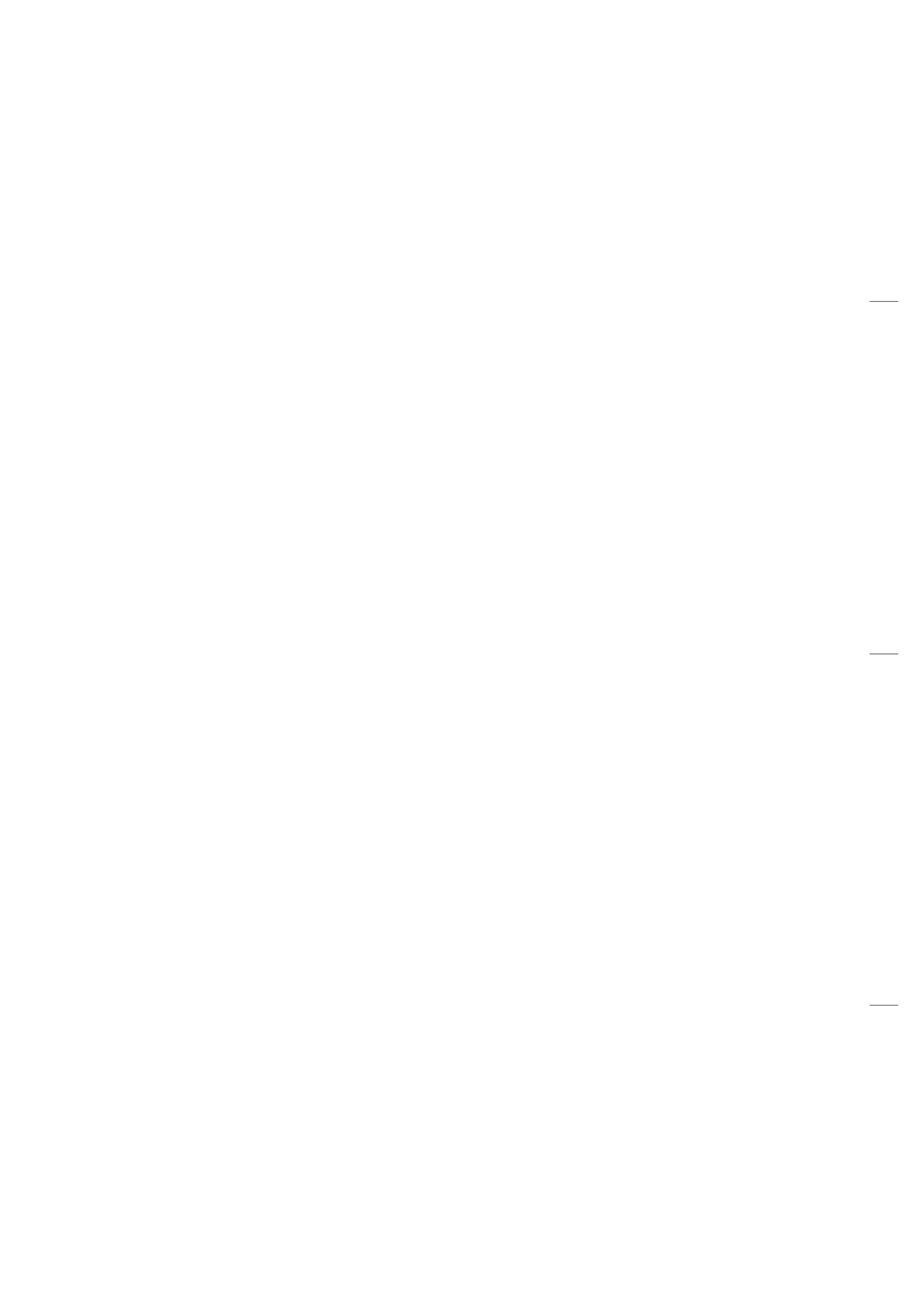
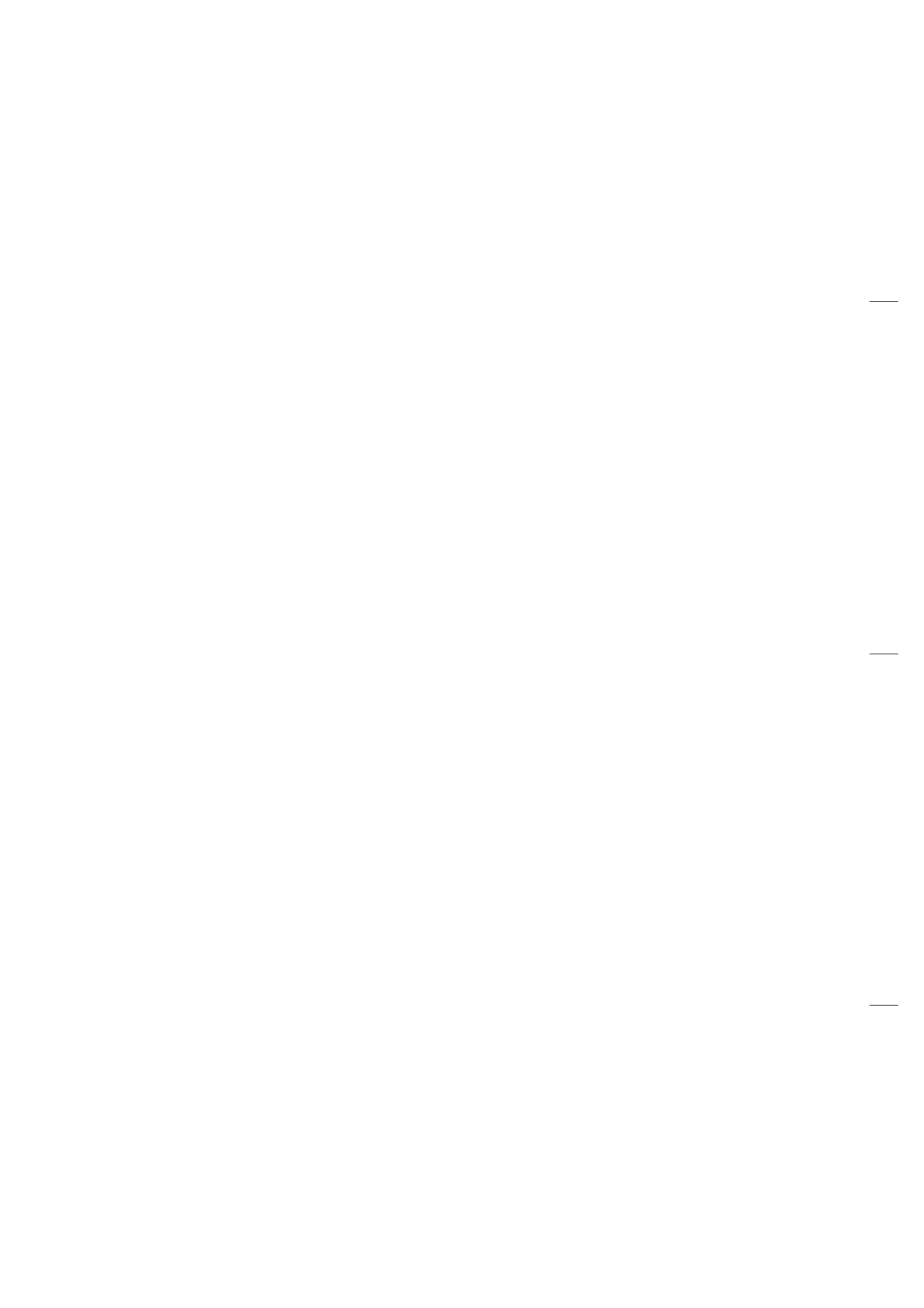

TABLE OF CONTENTS

<u>Title</u>	<u>Chapter Section Subject</u>	<u>Page</u>
STRUCTURES - GENERAL.....	51-00-00	1
Introduction	51-00-00	1
General Description	51-00-00	1
Structure Classes	51-00-00	2
COMPOSITE DAMAGE INVESTIGATION	51-10-00	201
General	51-10-00	201
Inspection Methods	51-10-00	201
Damage Classification	51-10-00	202
COMPOSITE REPAIR.....	51-20-00	201
General	51-20-00	201
Repair Requirements	51-20-00	201
Approved Materials	51-20-00	202
Tools, Equipment and Material	51-20-00	203
Material Data Sheet	51-20-00	204
Repair of Sandwich Components	51-20-00	217
Repair of Monolithic Components	51-20-00	222
Exterior Finish	51-20-00	223



STRUCTURES - GENERAL**1. Introduction**

- A. This chapter provides a general overview of the structural design. The chapter contains information and procedures applicable to all composite repairs as well as information and procedures for aircraft painting and priming.
- B. Please contact AQUILA Aviation GmbH for support in case damage to the aircraft structure the cause of which is unknown or suspect, and prior to major repairs to obtain detailed information.

AQUILA Aviation GmbH
Flugplatz
14959 Schönhagen
Germany

Tel.: +49(0) 33731 707-0
Fax.: +49(0) 33731 707-11

2. General Description

Most of the aircraft structure is made from composite materials. Glass-fiber (GFRP) and carbon-fiber reinforced plastics (CFRP) are used which are bedded in an epoxy resin matrix. The aircraft structure consists of monolithic GFRP or CFRP shells and structure components as well as sandwich shells which have a rigid foam core.

A. Fuselage

The fuselage with the vertical and horizontal stabilizers represents one component. Including the vertical stabilizer, it consists of two half-shells. The fuselage portion of the half-shells is made from solid (non-foam) fiberglass laminate, the vertical stabilizer has a sandwich structure. The fuselage GFRP skin is reinforced by four carbon-fiber stringers, arranged lengthwise through the entire fuselage.

Four ring frames and a baggage compartment frame provide support to the fuselage shells in the tail section. A landing gear bulkhead, a seat bulkhead and a side-force bulkhead carry single loads.

The front of fuselage ends with the firewall which includes the metal fittings for supporting the engine mount. The firewall, constructed of a GFRP/CFRP composite sandwich, has a fire protection lining on the front side which consists of an especially fire-resistant ceramic fleece and a stainless-steel sheet.

The landing gear bulkhead which together with the seat bulkhead supports the main landing gear struts, is complemented upwards through a compact CFRP/GFRP roll-over bar.

B. Wings

The plan view of the wing is a triple trapezoid that is complemented by a winglet at its end. The wing has top and bottom shells, constructed of a GFRP composite sandwich and locally reinforced by CFRP straps. The aircraft has a one-piece wing because the wing spar is manufactured in one piece and is continuous from wing tip to wing tip. The I-section spar has caps made from unidirectional carbon-fiber and a GFRP composite sandwich web. Each wing half ends inboard with a front root rib and a rear root rib, which are mounted to the fuselage center section with a bolt apiece.

The four lateral force bolts are inserted from the cabin through the fuselage bushings into the wing bolt casings and secured axially with screws.

The outboard end of the wing has a winglet with the NAV lights and the fuel tank vents. The inboard portion of the wings contains an integral fuel tank with a capacity of 60 liters per wing. The ailerons are located at the wing trailing edge near the wing tips. They are of a semi-monocoque sandwich construction consisting of rigid foam core and glass and carbon fiber layers. The flaps, of a semi-monocoque CFRP sandwich construction, are mounted to the trailing edge of each wing between the inboard end of the ailerons and the fuselage.

They are attached to the wings using hinges that are located below the bottom of the wing. This results in the gap between wing trailing edge and flap leading edge and increases as the flap extend. This increases the lift force and simultaneously the drag force.

C. Stabilizers

The vertical and horizontal stabilizers, as well as the elevator and rudder are of semi-monocoque design consisting of shells fabricated from GFRP sandwich reinforced with CFRP.

The vertical and the horizontal stabilizers have a main spar and a rear shear web with integrated hinges. The horizontal stabilizer is molded to the fuselage and cannot be removed.

3. Structure Classes

A. Primary Structure

These parts are important for the structural integrity of the aircraft. For example: fuselage, wing, stabilizer and control surface shells, spars, frames, joints, brackets.

B. Secondary Structure

These parts are not important for the structural integrity of the aircraft. For example: panels, covers, access plates, fairings.

COMPOSITE DAMAGE INVESTIGATION

1. General

- A. This section contains maintenance information and procedures such as investigation and damage classification applicable to fiber laminate structure components.

2. Inspection Methods

A. Visual Inspection

Most damage to a composite structure will be visually detectable. A wide variety of component surface discontinuities such as scratches, cracks, dimples, dents and creases may indicate damage. The use of optical aids such as flashlights, inspection mirrors and simple magnifiers is recommended. To allow remote visual inspection of internal surfaces or other inaccessible areas, a borescope can be used.

If the exterior surface is damaged, e.g. paint cracks, always assume that the underlying structure may also be damaged. To determine the extent of composite damage, other inspection methods may be additionally required.

B. Tap Testing

Tap testing is used for a quick evaluation of composite surfaces to detect the presence of delamination or debonding. The tap testing procedure consists of lightly tapping the surface of the part with a coin, special light hammer or any another suitable object. The acoustic response is compared with that of a known good area. Areas of disbonding or delamination will sound "flat" or "dead", undamaged areas should sound sharp and clear. The tap testing method should be used in conjunction with the exploration method.

C. Ultrasonic Inspection

Ultrasonic inspection can easily detect subsurface discontinuities, such as cracks, shrinkage cavities, bursts, pores, delaminations and porosity. This method is based on the fact that the amount of reflection that occurs when a sound wave strikes an interface depends largely on the physical state of the materials forming the interface and to a lesser extent on the specific physical properties. The ultrasonic instrument generates an ultrasonic pulse, detects and amplifies the returning echo and displays the detected signal on a cathode ray tube or similar display. For specific inspection procedures refer to manufacturer publications of the ultrasonic test equipment used. If a flaw is detected, further exploration of the suspect composite area as described below is required.

D. Exploration

Exploration is an extension of visual inspection, but requires removal of the facing coat. The exploration method must be employed when subsurface damage has been detected by tap testing, during ultrasonic inspection or to determine the precise extend of damage.

3. Damage Classification

A. Damage to composite structures can be divided into four classes:

- (1) **Damage Class 1**
Severe, extensive damage that requires partial component restoration or general component replacement.
- (2) **Damage Class 2**
Damage to primary or secondary structures with sandwich penetration such as holes or fractures. Both sides of sandwich penetrated and the laminate on both sides must be repaired and the core section replaced.
- (3) **Damage Class 3**
Damage only to outer laminate layers on one side of a sandwich construction without or only minor gouging of core material.
- (4) **Damage Class 4**
Damage to outer surface of composite structures such as superficial scars, scratches, surface abrasion or erosion. No holes or laminate fractures.

B. **Minor Damages**

Only the damages listed below can be considered as small damages and repaired by qualified personnel without a repair scheme which has been approved by the manufacturer. In general all damages in force introduction or reinforced areas (i.e. spars, ribs) have to be carried out by certified repair stations for composite aircraft structure works.

- (1) Any damages limited to varnish or filler.
- (2) Damages not exceeding the permissible dimensions of holes, dents and cracks that are listed in the following table:

Part	Average hole or dent diam.	Crack length
Front fuselage (cockpit)	50 mm [2 in.]	75 mm [3 in.]
Rear fuselage (tail boom)	25 mm [1 in.]	50 mm [2 in.]
Wing	75 mm [3 in.]	100 mm [4 in.]
Stabilizers	25 mm [1 in.]	50 mm [2 in.]
Flap, Aileron	25 mm [1 in.]	50 mm [2 in.]
Rudder, Elevator	25 mm [1 in.]	50 mm [2 in.]
Cowling, Fairings	75 mm [3 in.]	100 mm [4 in.]

- (3) Damages not affecting glass and carbon rovings or carbon tapes in the primary structure.
- (4) No class 1 damages and no damages in critical areas. Refer to figure 201 for an overview of the main critical areas of the aircraft.

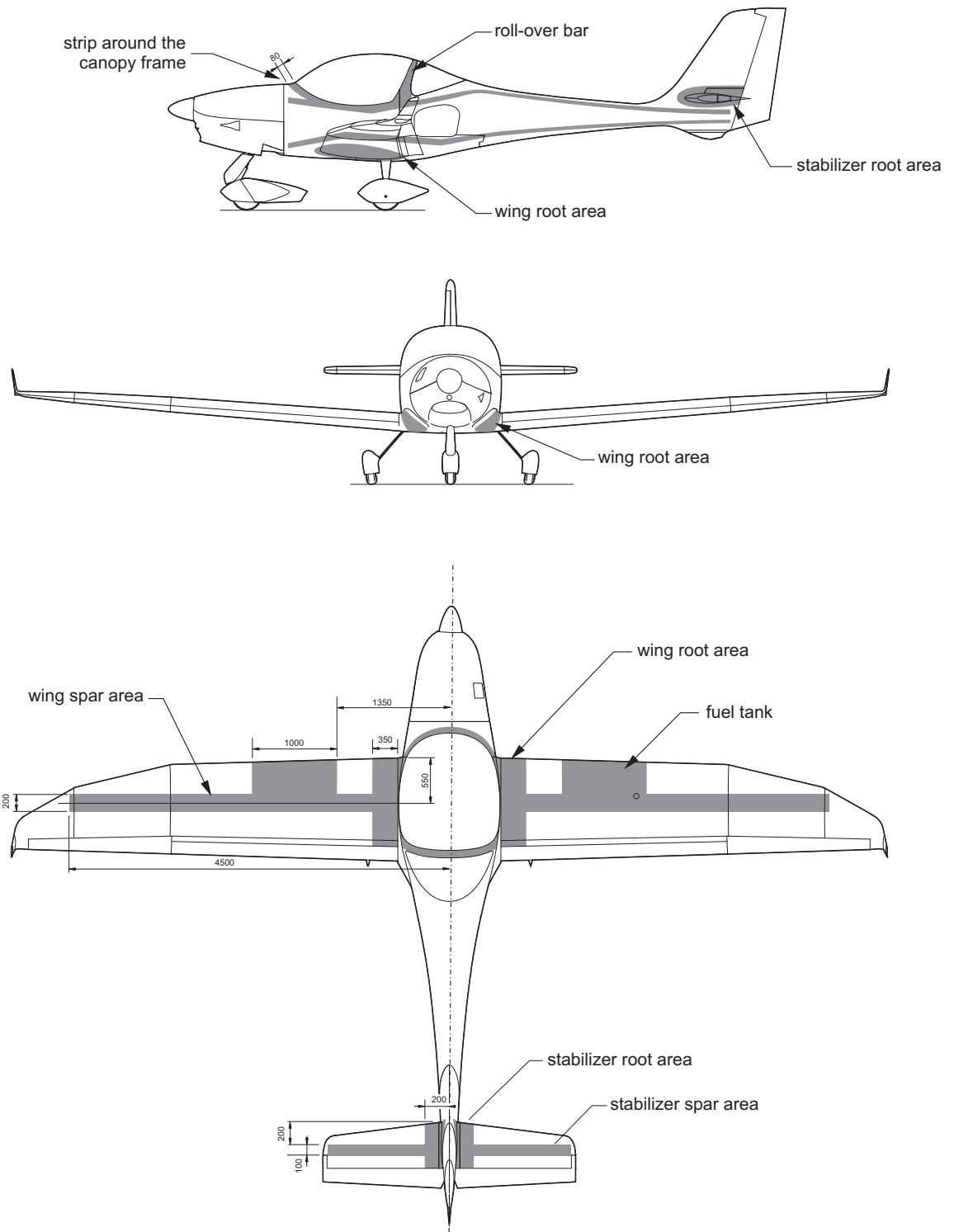

Damages - Critical Areas
Figure 201

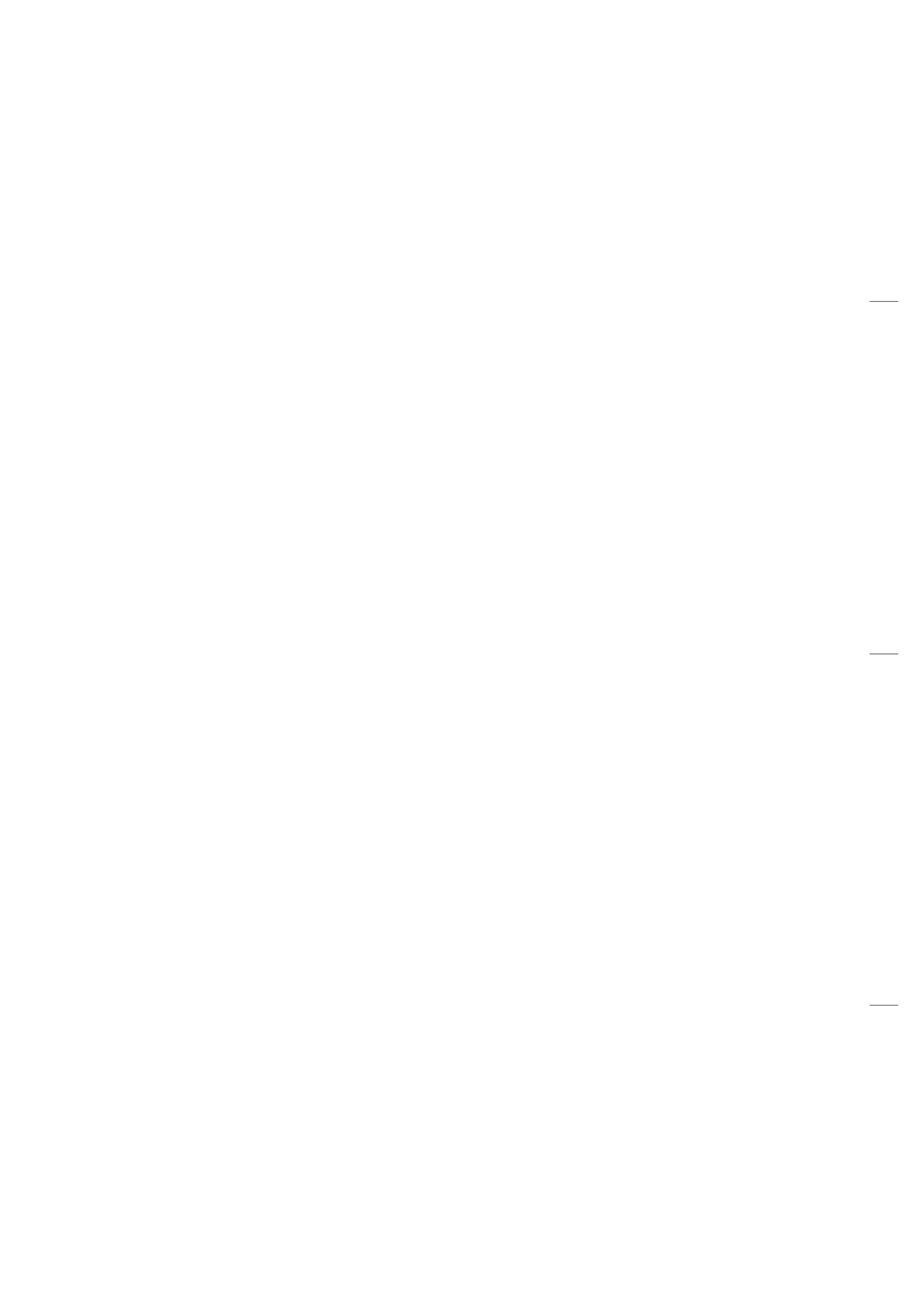

COMPOSITE REPAIR

1. General

- A. This section covers required information to complete successful repairs to aircraft components that are made from fiber laminate. Necessary repair data, such as ply lay-up and ply orientation for various areas, as well as repair materials and procedures are provided. Not included are general practices used during most composite repairs, such as cleaning and preparing the damaged area, proper preparation of materials, mixing and applying resin or proper curing the repair. Personnel must be familiar with these practices prior to attempting fiberglass composite repairs on this aircraft.

2. Repair Requirements

- A. The following requirements must be met:
- (1) Repairs for which no description is given in this chapter may only be carried out in accordance with a repair scheme which must be approved in accordance with the procedures established by the competent certifying authority.
 - (2) Only damages classified as minor damages (refer to 51-10-00) can be repaired by qualified personnel without a repair scheme which has been approved by the manufacturer or cognizant regulatory authority.
 - (3) In general all damages in force introduction or reinforced areas (i.e. spars, ribs) have to be carried out by certified repair stations for composite aircraft structure works or properly certified and trained persons.
 - (4) Class 4 damages (refer to 51-10-00) don't have to be repaired immediately after detection if adequately protected from environmental conditions (e.g. adhesive tape).
 - (5) Repairs must be completed by competent technicians trained in composite repair.
 - (6) Before beginning a repair make sure all required tools, equipment and materials are ready. If you are not familiar with the proper use of all the repair tools, never attempt a fiberglass composite repair.
 - (7) Use the approved materials outlined in this section only. Prepare materials in accordance with information given in this manual and manufacturer instructions.
 - (8) Review material safety data sheets for material to be used. Observe shelf life.
 - (9) Repairs should be made in a clean, temperature controlled environment. Optimal repair temperature lies between 16°C and 27°C (60°F - 80°F) with 50% relative humidity or less.
 - (10) It is recommended to prepare a test specimen during actual repair which can be subjected to a destructive test to establish the quality of the adhesive bond in the repaired part.
 - (11) To preserve the good aerodynamic characteristics of the aircraft smooth and precisely contour repaired surfaces.
 - (12) All control surfaces have to be checked for weight and control surface moment after repair.
- B. Safety Precautions
- (1) Read and adhere to all manufacturer instructions, warnings and cautions on the materials and chemicals used.
 - (2) Sanding fiber laminates results in a fine dust that may cause skin and/or respiratory irritation unless suitable protection is used.
 - (3) Never handle fabric materials with bare hands, use clean cotton or rubber gloves.

- (4) Solvents used in repair processes are composed of a group of chemicals that often prove toxic. To avoid toxic poisoning, work in a well-ventilated area only and always be alert for symptoms of poisoning. If symptoms are observed, it is vital to immediately remove the person from the contaminated area.
- (5) Protective clothing should be worn to avoid skin contact with chemical substances.
- (6) Many of the chemicals used are flammable.

3. Approved Materials

Description	Number / Specification	Manufacturer / Supplier
Carbon fiber roving	Tenax-J HTA-1600	TENAX fibers GmbH & Co.KG Kasinostr. 19-21 42097 Wuppertal
Glass fiber roving	EC14(2400)P185	Vetrotex Reinforcement GmbH Bicherouxstraße 61 52134 Herzogenrath
Carbon fiber tape	Carbon UD-UD CST240/60	Epo GmbH Siemensring 31-33 47877 Willich
Glass fiber fabric	IG 02034 IG 90070 IG 92110 IG 92125 IG 92140	P-D INTERGLAS GmbH Benzstraße 14 89155 Erbach
Carbon fiber fabric	IG 98140	P-D INTERGLAS GmbH Benzstraße 14 89155 Erbach
Resin repair system	Scheufler L285 H285, H286, H287	Martin G. Scheufler Kunsthartzprodukte GmbH Am Ostkai 21/22 70327 Stuttgart
Cell foam	Divinicell H60	Lange+Ritter GmbH Dieselstr. 25 70839 Gerlingen
Polyester filler		any source

4. Tools, Equipment and Material

	Quantity	Equipment	Parts No.	Manufacturer
6.A.	as required	sandpaper 30-grit to 400 grit	-	commercially available
	as required	isopropyl alcohol	-	commercially available
	as required	peel ply	-	commercially available
	as required	release film	-	commercially available
	as required	hot glue	-	commercially available
	as required	cotton cloth	-	commercially available
	1	mixing container	-	commercially available
	as required	stir sticks	-	commercially available
	1	scale	-	commercially available
	1 pair	gloves	-	commercially available
8.A.	as required	masking tape 2-inch	-	commercially available
	as required	sandpaper 240-grit to 360-grit	-	commercially available
	as required	cotton cloth	-	commercially available
	as required	isopropyl alcohol	-	commercially available

	as required	2k epoxy primer activator thinner	LE2001 XK206 EV301	DuPont
8.B.	as required	cotton cloth	-	commercially available
	as required	isopropyl alcohol	-	commercially available
	as required	coating activator thinner	PUR EV310 PUR EV313 PUR EV303	DuPont

5. Material Data Sheet

- A. The material data sheet in combination with figures 202 (fuselage), 203 (wing), 204 (flap), 205 (aileron), 206 (elevator) and 207 (rudder) should be used for information on ply lay-up and ply orientation. The item numbers give the order in which the layers are applied.

Item No.	Layers	Description	Remarks
1	1	Interglas 92110	width 80 mm
2	1	Interglas 92110	width 100 mm
3	1	Interglas 92125	overall
4	1	Interglas 92140	
5	1	Interglas 92125	max. width 125 mm
6	2	Interglas 92125	width 200 mm
7	-	DH 60-06	rigid foam
8	1	Interglas 92125	
9	1	Interglas 92110	
10	4	CST 240/60	overall
11	3	CST 240/60	fr. wind. up to end of tail
12	7	CST 240/60	overall
13	3	CST 240/60	
14	5	CST 240/60	
15	2	CST 240/30	
16	1	Interglas 92140	overall
17	4	CST 240/30	up to baggage bulkhead
18	2	Interglas 92125	stringer covering
19	1	Interglas 92125	up to baggage bulkhead
20	1	Interglas 92125	sidewalls only
21	1	Interglas 92140	bottom only
22	1	Interglas 92125	bottom only
23	1	Interglas 92140	sidewalls only

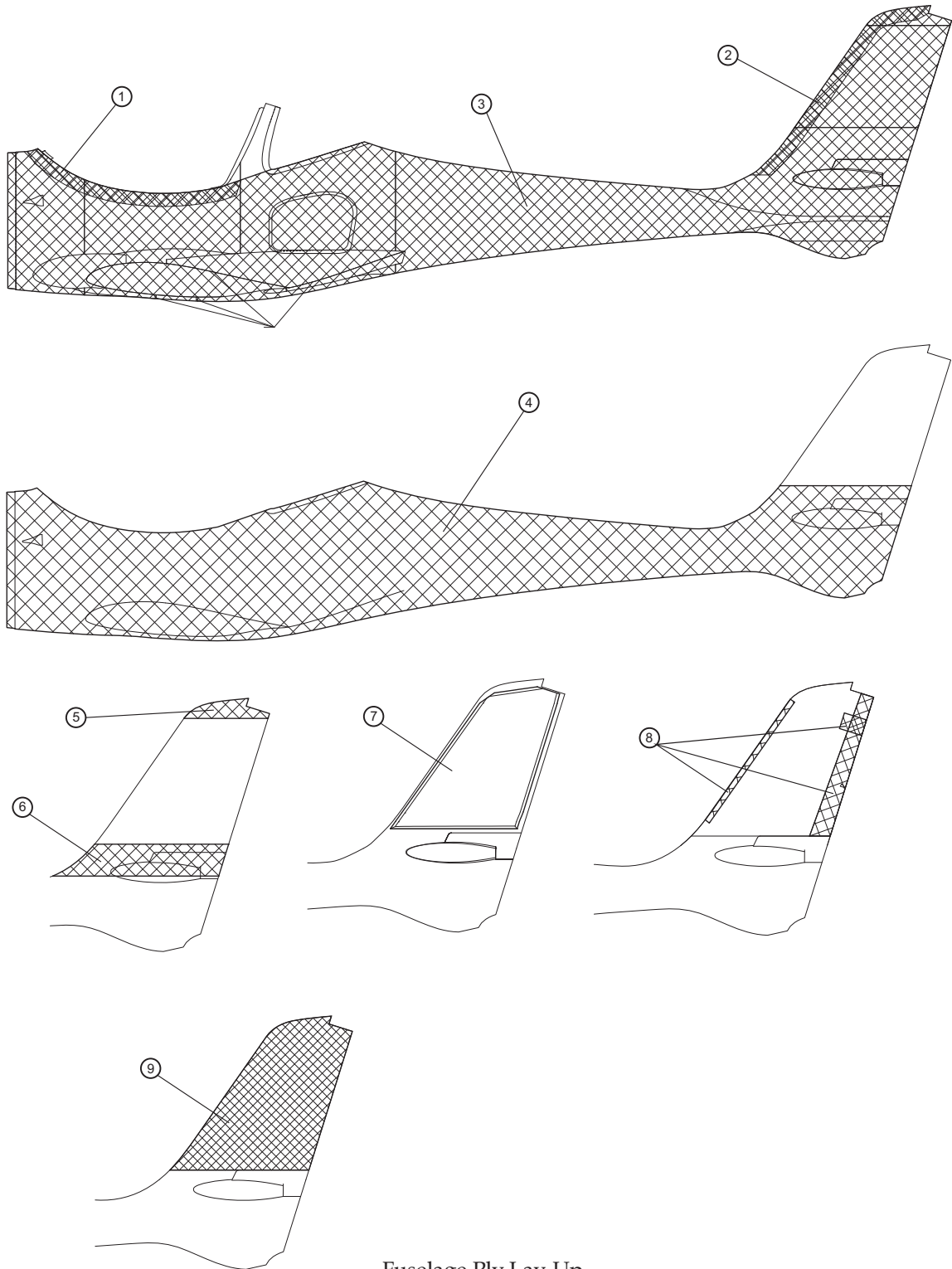

Fuselage Ply Lay-Up
Figure 202 (1)

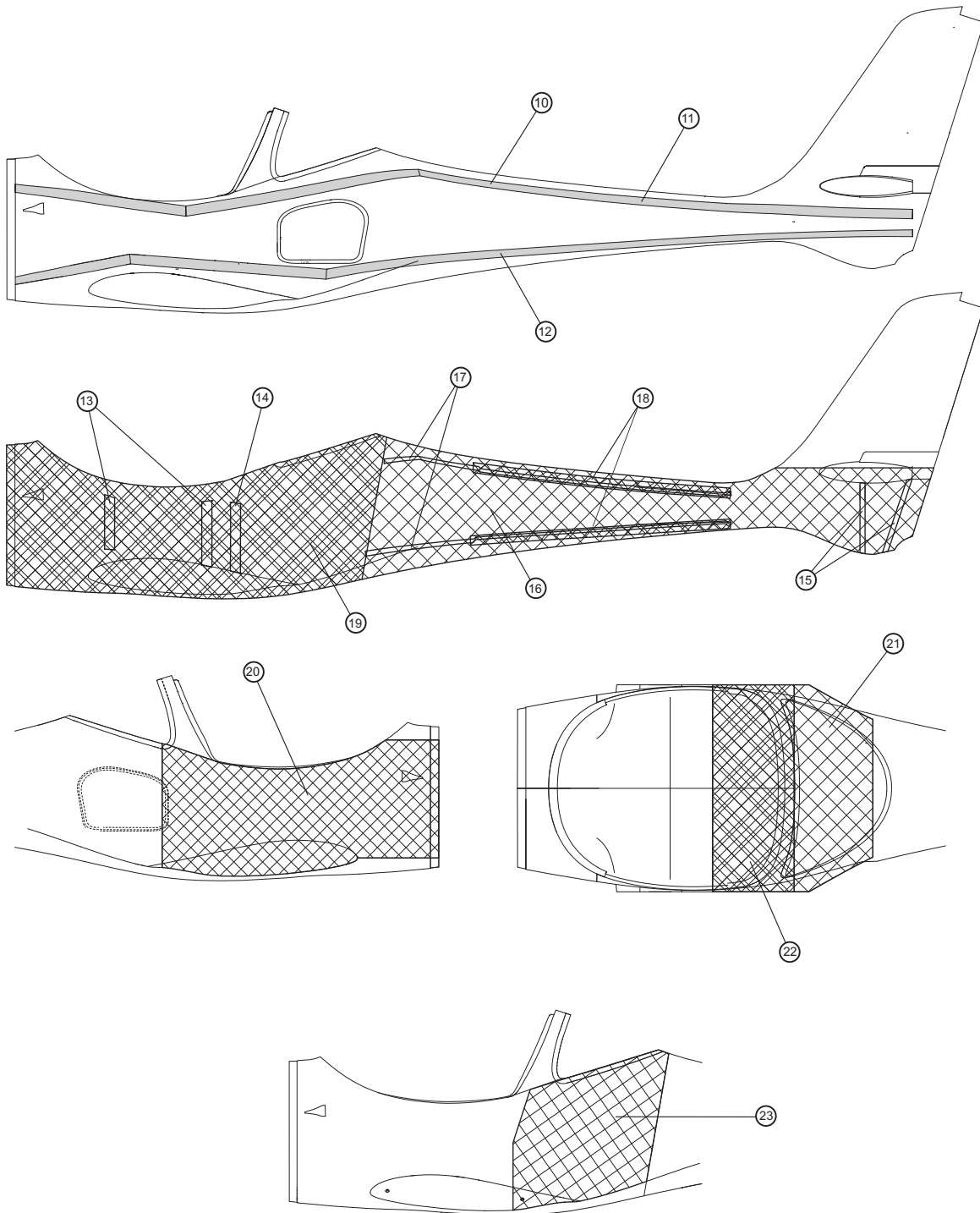

Fuselage Ply Lay-Up
Figure 202 (2)

Item No.	Layers	Description	Remarks
1	1	Interglas 92110	width 110 mm
2	1	Interglas 92125	
3	1	Interglas 92125	width 100 mm strip, overlap in winglet area
4	1	Interglas 92125	
5	1	Interglas 92125	
6	2	Interglas 92125	up to aileron
7	1	Interglas 92125	up to y=1030 mm
8	1	Interglas 92125	
9	2	Interglas 92125	
10	2	Interglas 92125	only left-hand side
11	2	CST 240/60	length 800 mm
12	1	CST 240/60	length 280 mm
13	1	CST 240/60	length 330 mm
14	1	CST 240/60	
15	2	CST 240/30	obliquely outwards
16	2	CST 240/30	
17	2	roving 5x EC 14-2400 P185	
18	8	roving 5x EC 14-2400 P185	
19	6	roving 5x EC 14-2400 P185	
20	1	Interglas 90070	
21	1	Interglas 92110	from 1350 mm
22	1	Interglas 92125	up to 2350
23	1	Interglas 92110	
24	1	Interglas 92110	circle 123 mm x 63 mm, centered beneath filler
25	1	Interglas 92125	strip width 80 mm, overlap in winglet area
26		Interglas 92125	strip 240 mm x 50 mm, bent around filler
27	3	roving 5x EC 14-2400 P185	wrapped around filler
28	3	Interglas 92125	graduated by 5 mm
29	1	Interglas 90070	
30	1	Interglas 92110	
31		DH 60 - 08	rigid foam
32		Pregnit GGBE/GMBE	GFRP plate
33	2	CST 240/30	at 50% winglet depth, up to 60 mm before winglet end

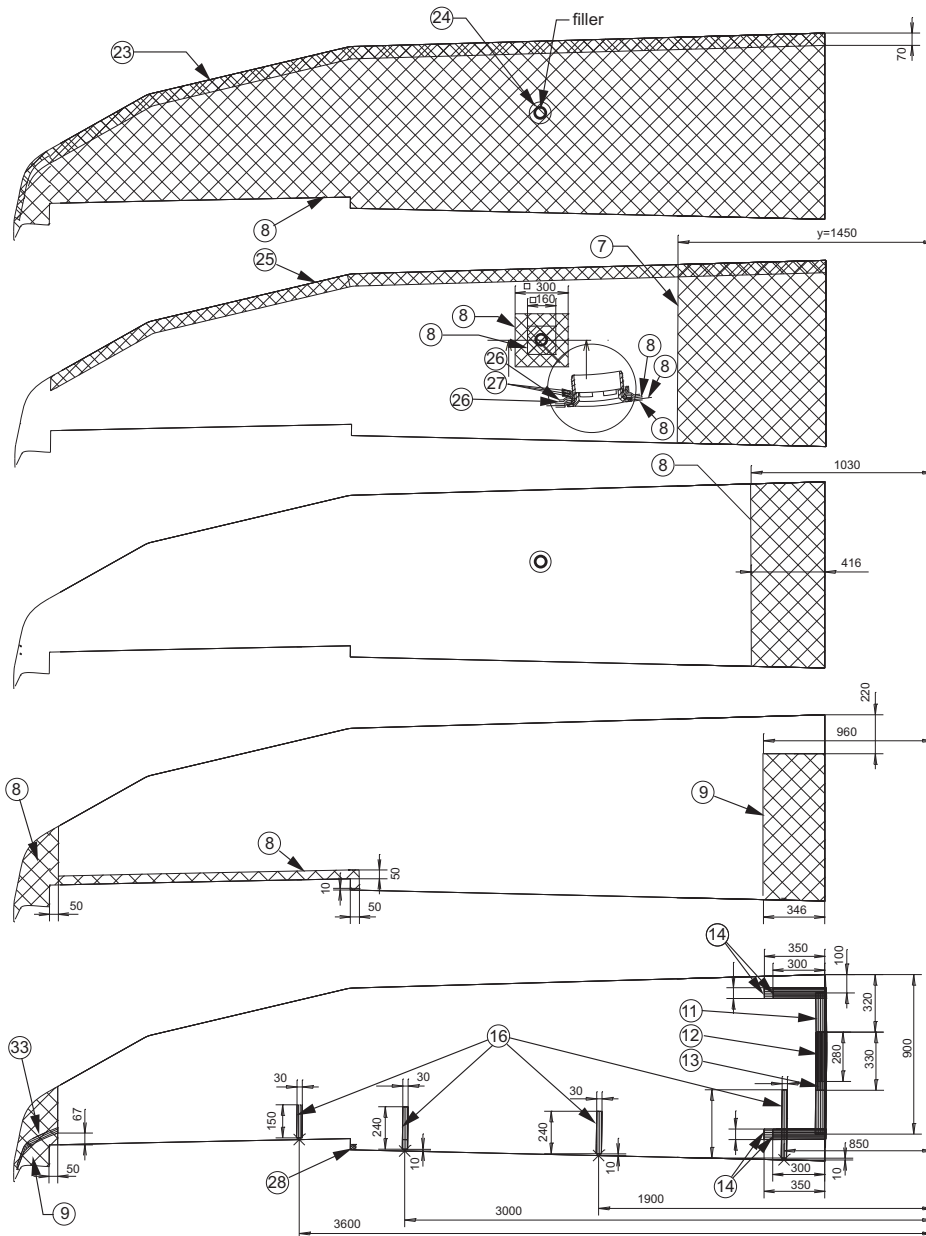

Upper Wing Shell Ply Lay-Up
Figure 203 (1)

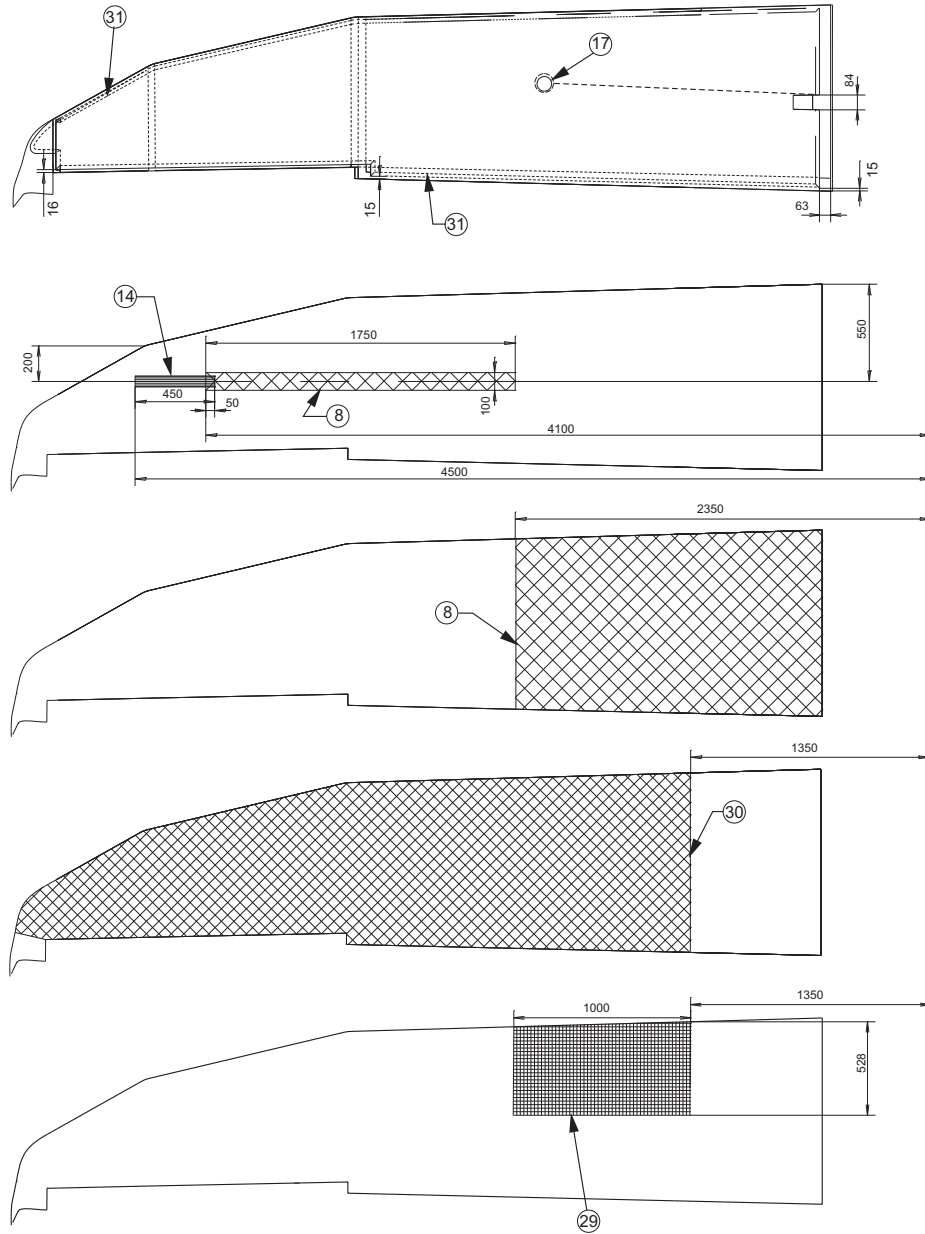

Upper Wing Shell Ply Lay-Up
Figure 203 (2)

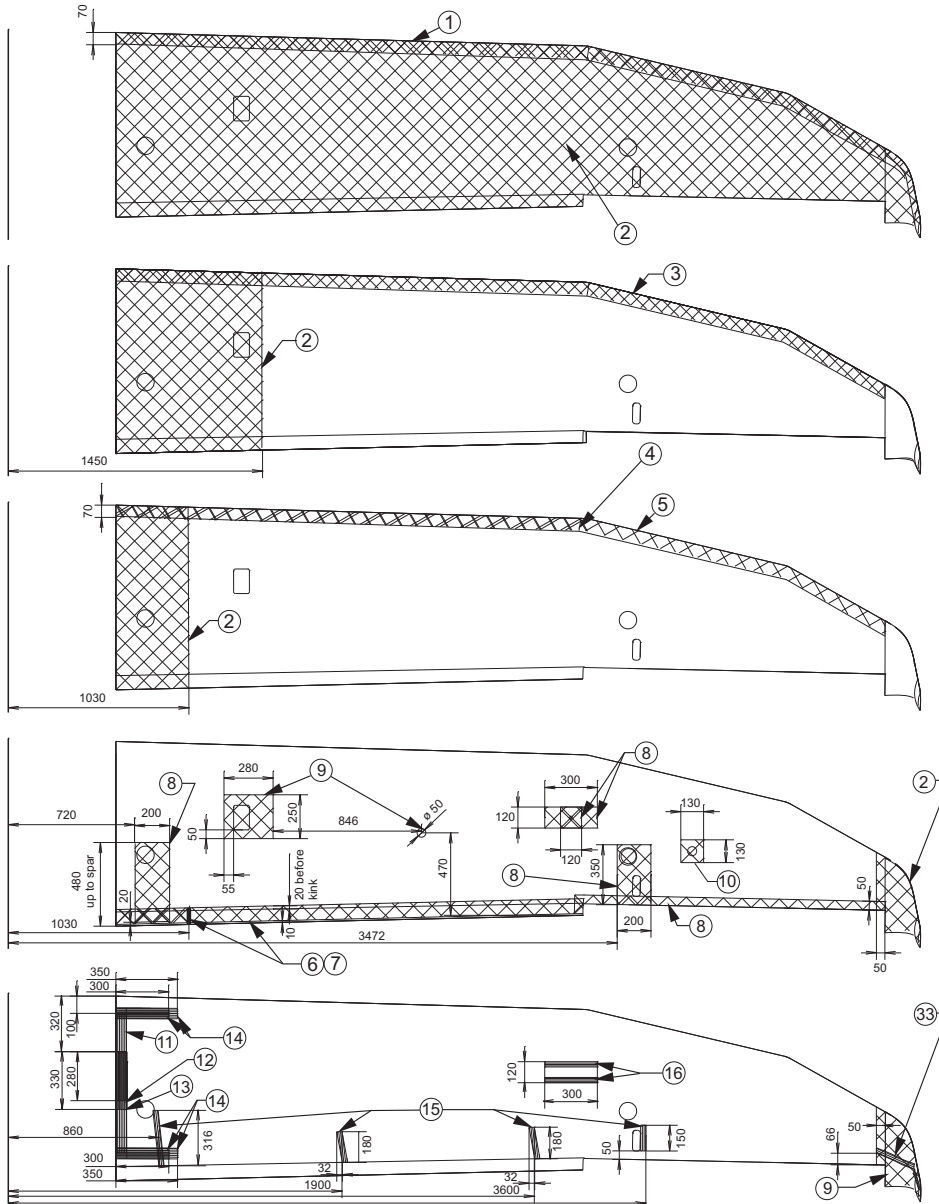

Lower Wing Shell Ply Lay-Up
Figure 203 (3)

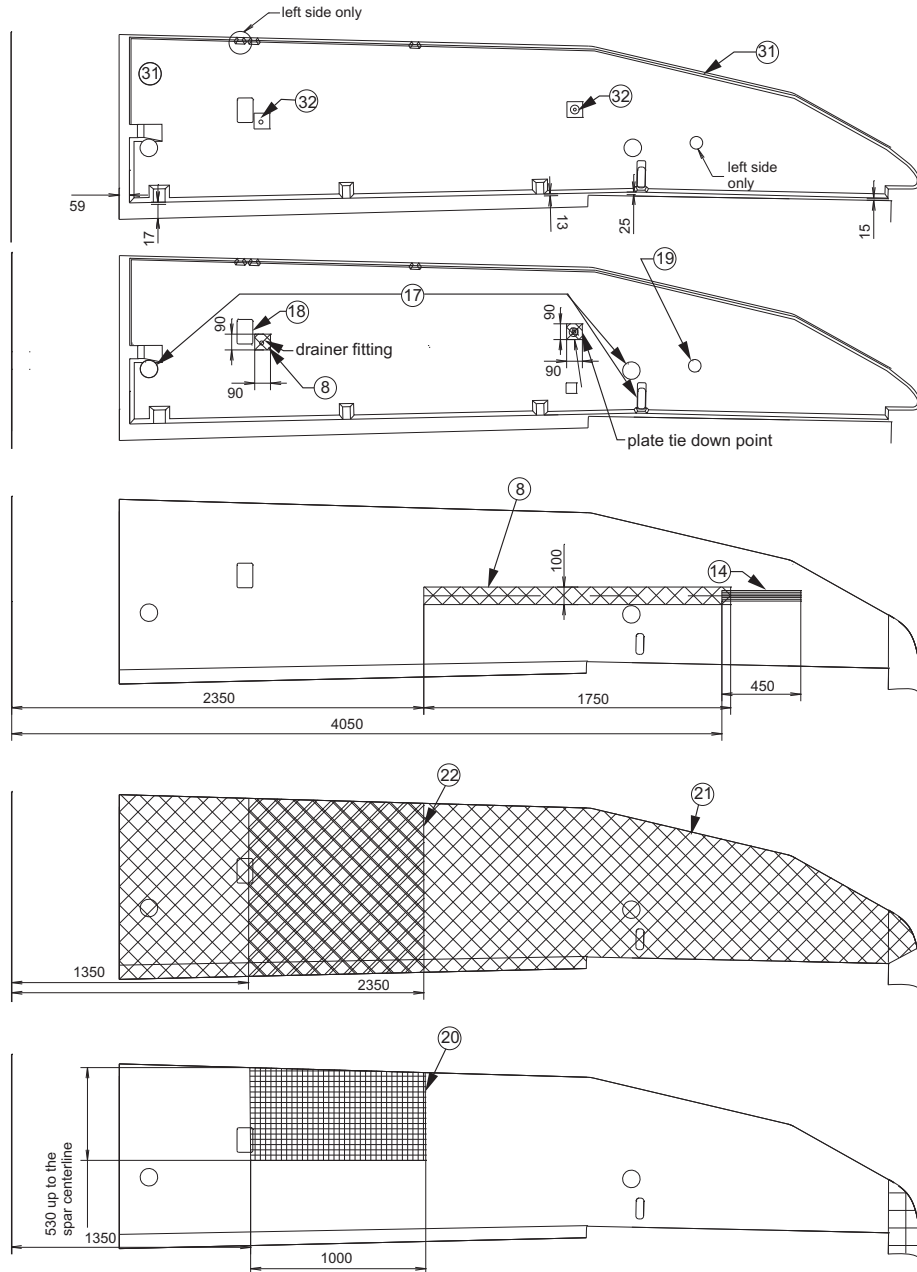

Lower Wing Shell Ply Lay-Up
Figure 203 (4)

Item No.	Layers	Description	Remarks
1	1	Interglas 90070	overall
2	1	Interglas 98140	overall
3	1	Interglas 98140	width 400 mm (on fuselage side)
4	1	CST 240/60	
5	-	DH60-03	rigid foam
6	1	Interglas 98140	overall

Ply lay-up for upper / lower flap shell and LH / RH flap symmetrical.

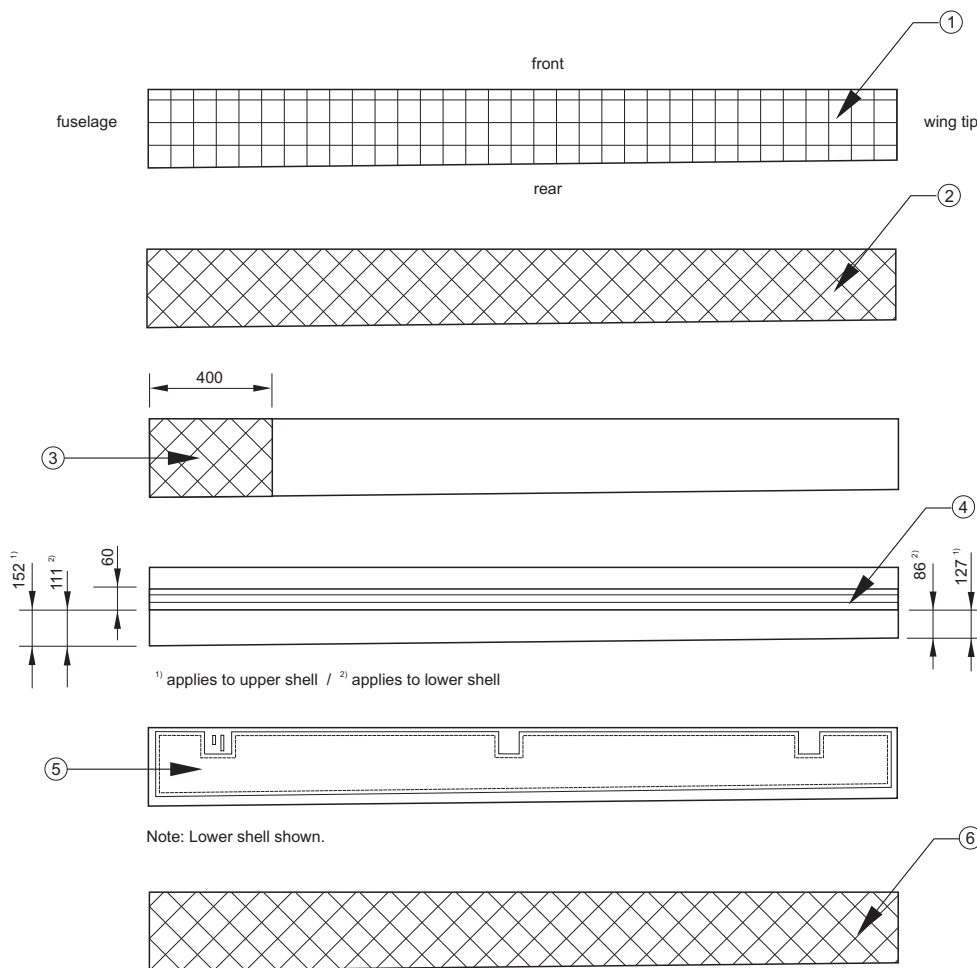

Flap Shell Ply Lay-Up
Figure 204

Item No.	Layers	Description	Remarks
1	1	Interglas 92110	overall
2	2	CST 240/30	
3	2	Interglas 92125	
4	-	DH60-03	rigid foam
5	1	Interglas 92110	
6	1	Interglas 92110	overall

Ply lay-up for upper / lower aileron shell and LH / RH aileron symmetrical.

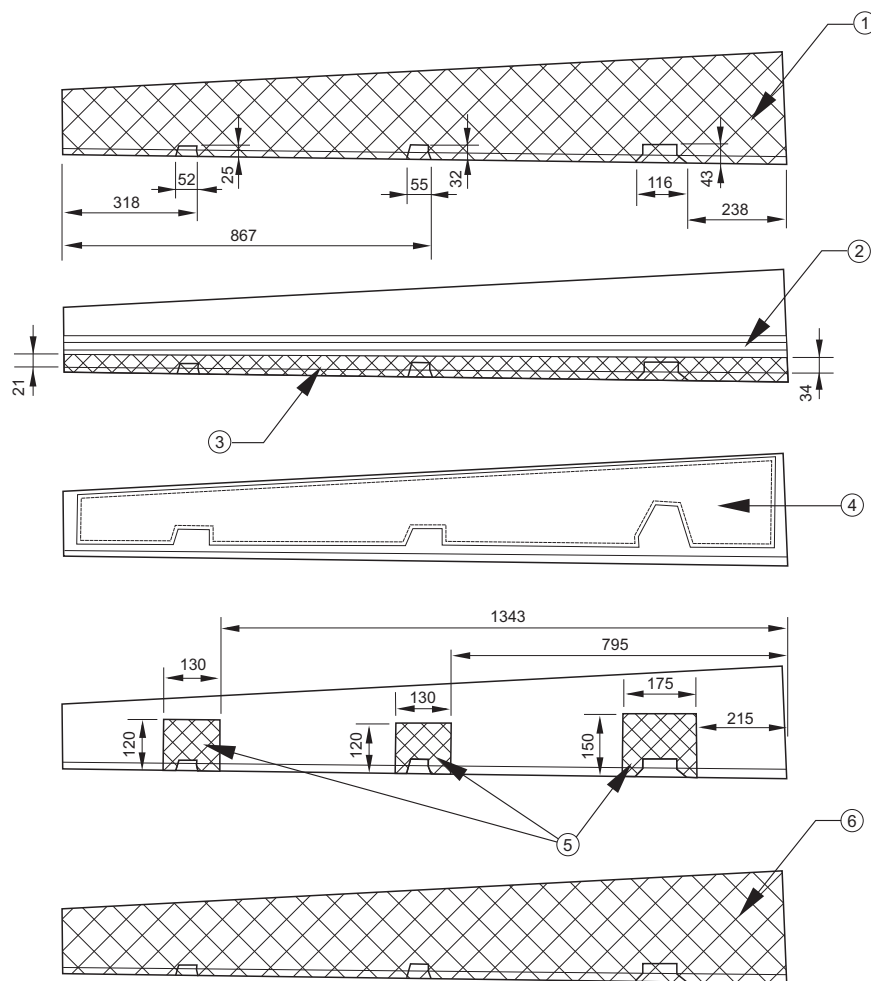

Aileron Shell Ply Lay-Up
Figure 205

Item No.	Layers	Description	Remarks
1	1	Interglas 92110	overall
2	1	Interglas 92110	
3	1	Interglas 92125	
4	1	Interglas 92125	
5	1	CST 240/30	
6	-	DH60-03	rigid foam
7	1	Interglas 92110	
8	1	Interglas 92110	overall

Ply lay-up for upper / lower elevator shell and LH / RH elevator symmetrical.

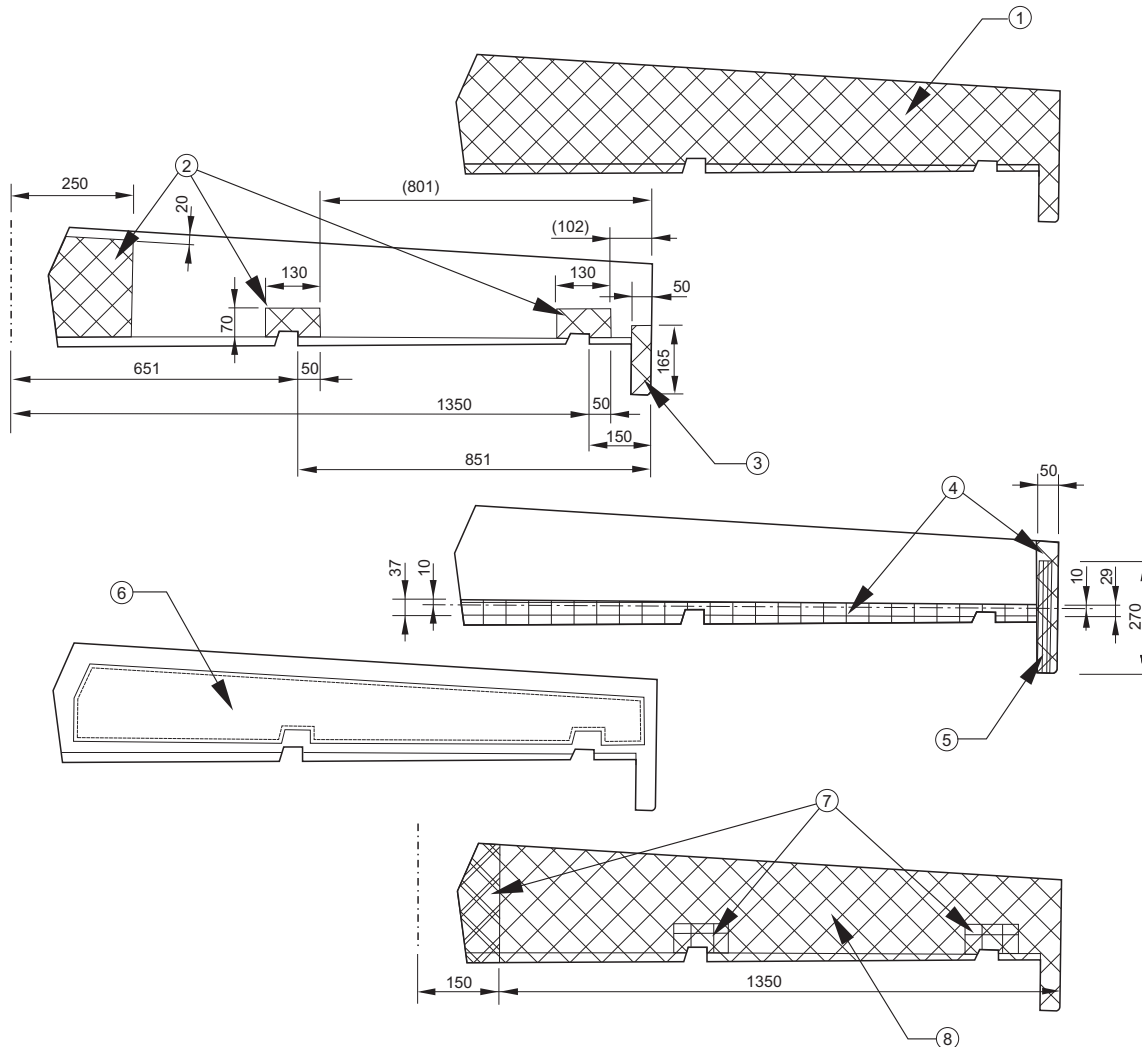

Elevator Shell Ply Lay-Up
Figure 206

Item No.	Layers	Description	Remarks
1	1	Interglas 92110	overall
2	1	CST 240/60	
3	2	Interglas 92110	
4	1	Interglas 92110	
5	4	Interglas 92125	
6	2	Interglas 92125	
7	-	DH60-03	rigid foam
8	1	Interglas 92110	
9	1	Interglas 92125	
10	1	Interglas 92110	overall

Ply lay-up for LH / RH rudder shell symmetrical.

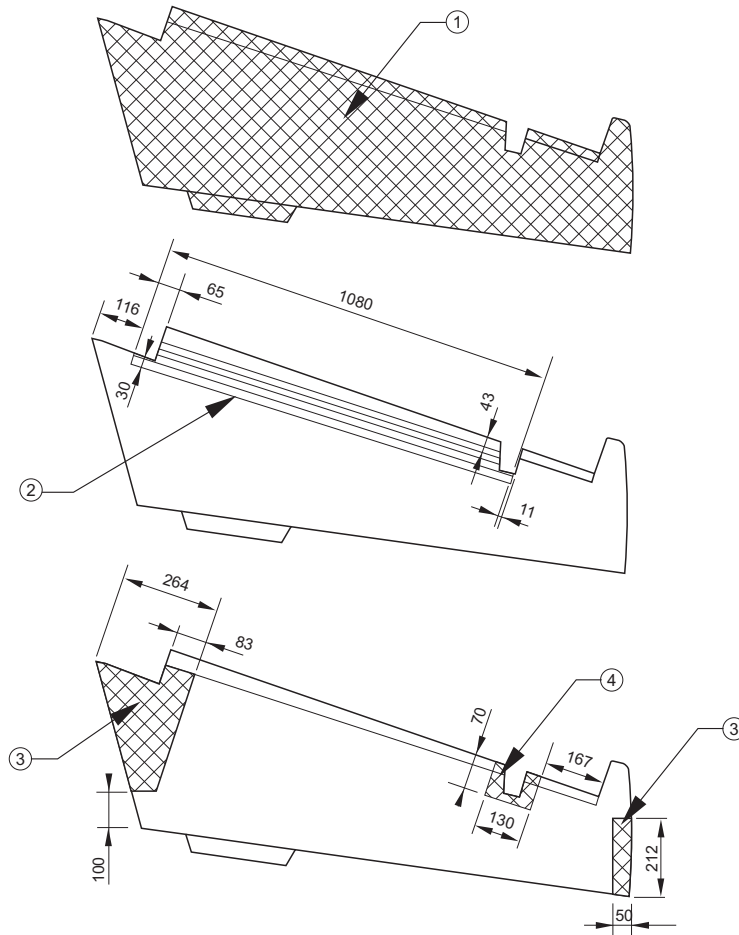

Rudder Shell Ply Lay-Up
Figure 207 (1)

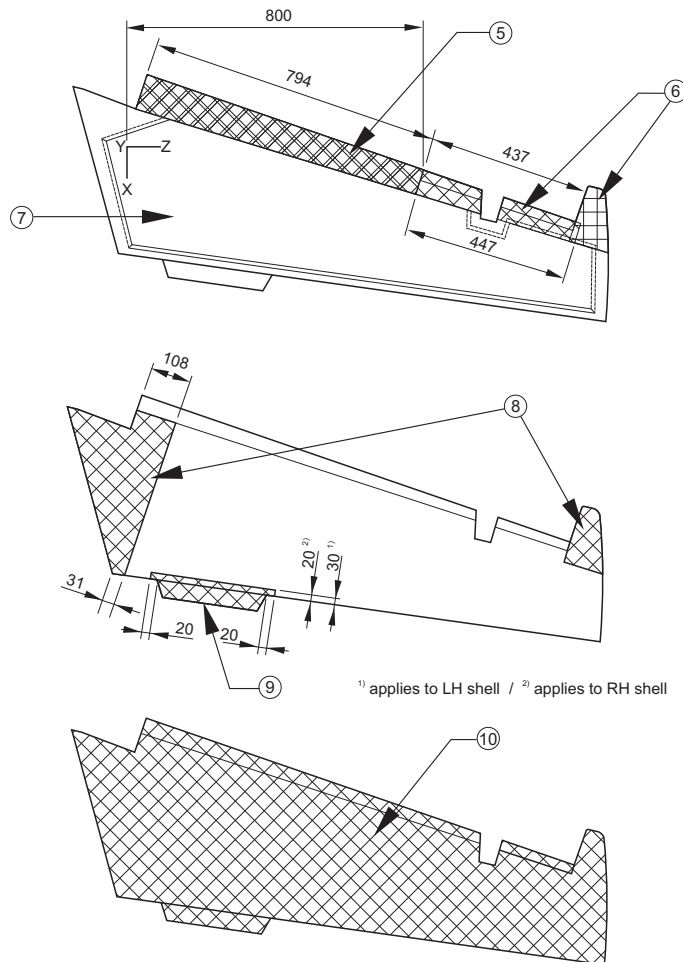

Rudder Shell Ply Lay-Up
Figure 207 (2)

6. Repair of Sandwich Components

A. Material Specifications

Type	Material	Weave	Weight	Thickness	Scarf
Interglas 90070	glass	plain	80 g/m ²	0,07 mm	4 mm
Interglas 92110	glass	2/2 twill	163 g/m ²	0,14 mm	8 mm
Interglas 92125	glass	2/2 twill	280 g/m ²	0,25 mm	14 mm
Interglas 92140	glass	2/2 twill	390 g/m ²	0,35 mm	20 mm
Interglas 98140	carbon	plain	204 g/m ²	0,26 mm	18 mm

B. Outer Laminate Repair (surface defects)

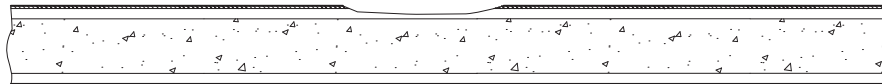

- (1) Remove surface finish from damaged area. Carefully examine the area around the damage. Check for disbonding between laminate layers and core material.
- (2) Remove damaged/loose laminate by sanding with 80-grit sandpaper.
- (3) Scarf the edges of the repair area with a grinding disk or block (refer to "Material Specifications" above for scarf size).

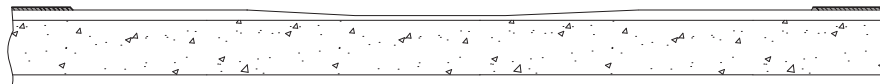

- (4) Solvent clean prepared area.
- (5) Lay up repair plies according to the existing layer direction (refer to "Material Data Sheet" above). If the layer orientation is not clear please contact AQUILA Aviation GmbH.

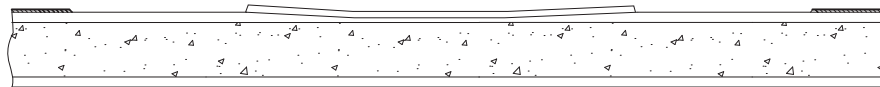

- (6) Pre-cure the repair at least 24 hours at 20°C (68°F) to 25°C (77°F).
- (7) Post-cure the repair at least 15 hours at 54°C (129°F) to 60°C (140°F).
- (8) Sand the repair surface down to contour.
- (9) Refinish the repair area as described in "Exterior Finish" below.

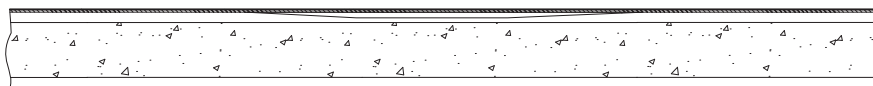

C. Minor Core Damage



- (1) Remove surface finish from damaged area. Carefully examine the area around the damage. Check for disbonding between laminate layers and core material.
- (2) Remove damaged/loose laminate by sanding with 80-grit sandpaper.
- (3) Scarf the edges of the repair area with a grinding disk or block (refer to "Material Specifications" above for scarf size).
- (4) Solvent clean prepared area.
- (5) Fill the damaged foam area with resin thickened by microballoons and allow to cure.
- (6) Sand the repair area down to contour.

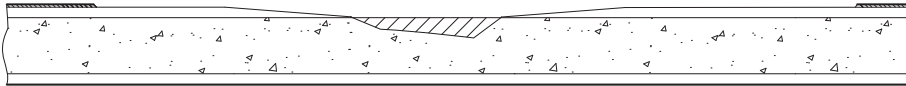

- (7) Solvent clean prepared area.
- (8) Lay up repair plies according to the existing layer direction (refer to "Material Data Sheet" above). If the layer orientation is not clear please contact AQUILA Aviation GmbH.

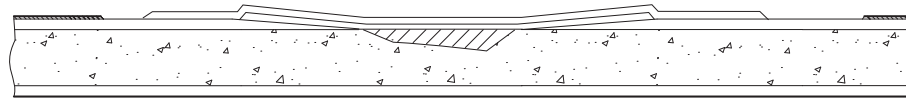

- (9) Pre-cure the repair at least 24 hours at 20°C (68°F) to 25°C (77°F).
- (10) Post-cure the repair at least 15 hours at 54°C (129°F) to 60°C (140°F).
- (11) Sand the repair surface down to contour.
- (12) Refinish the repair area as described in "Exterior Finish" below.

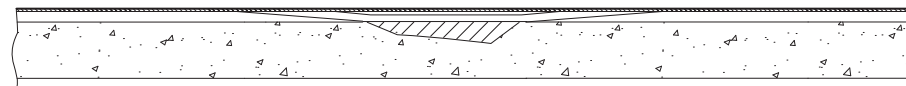

D. Core Replacement



- (1) Remove surface finish from damaged area. Carefully examine the area around the damage. Check for disbonding between laminate layers and core material.
- (2) Remove damaged/loose laminate and core and carefully trim out to a circular or oval shape. Check edge of damage for separation of core and inner laminate. Check inner laminate for damage and repair first if required.
- (3) Scarf the edges of the repair area with a grinding disk or block (refer to "Material Specifications" above for scarf size).



- (4) Solvent clean prepared area.
- (5) Prepare a replacement core (refer to "Material Data Sheet" above) and fit it snugly in the trimmed shape. Leave a small amount of clearance for resin microballoon mixture.
- (6) Bond in replacement core with resin thickened by microballoons and allow to cure.

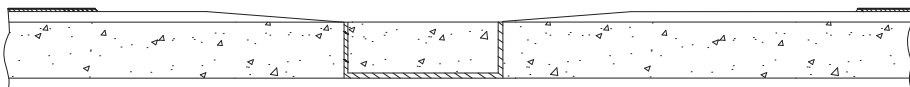

- (7) Sand the replacement core down to contour.
- (8) Solvent clean prepared area.
- (9) Lay up repair plies according to the existing layer direction (refer to "Material Data Sheet" above). If the layer orientation is not clear please contact AQUILA Aviation GmbH.

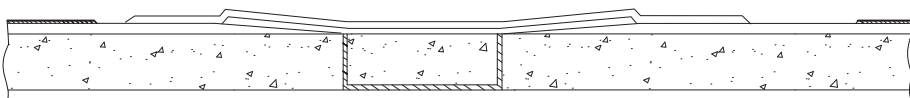

- (10) Pre-cure the repair at least 24 hours at 20°C (68°F) to 25°C (77°F).
- (11) Post-cure the repair at least 15 hours at 54°C (129°F) to 60°C (140°F).
- (12) Sand the repair surface down to contour.
- (13) Refinish the repair area as described in "Exterior Finish" below.

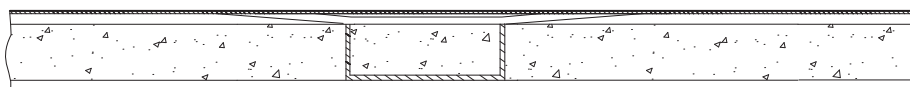

E. Inner Laminate Repair (sandwich penetration, access to inner side)

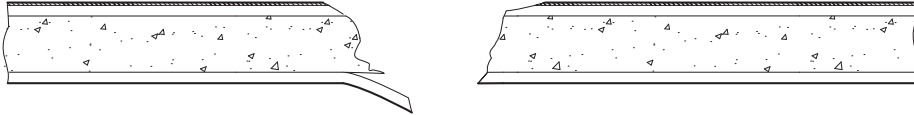

- (1) Remove surface finish from damaged area. Carefully examine the area around the damage. Check for disbonding between laminate layers and core material.
- (2) Remove damaged/loose laminate and core and carefully trim out to a circular or oval shape. Check edge of damage for separation of core and inner laminate.
- (3) Scarf the edges of the repair area with a grinding disk or block (refer to "Material Specifications" above for scarf size).

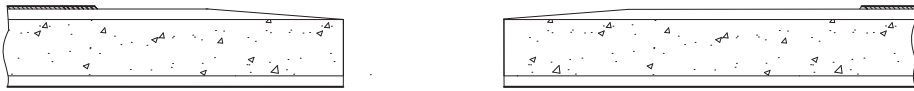

- (4) Solvent clean repair area.
- (5) Prepare a temporary backing plate and shim and glue it to inner laminate.
- (6) Prepare a replacement core (refer to "Material Data Sheet" above) and fit it snugly in the trimmed shape. Leave a small amount of clearance for resin microballoon mixture.
- (7) Bond in replacement core with resin thickened by microballoons and allow to cure.

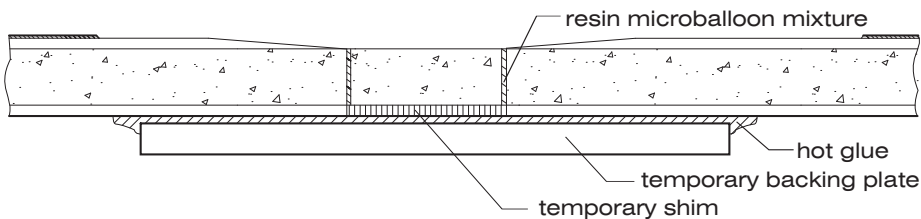

- (8) Sand down the replacement core to contour.
- (9) Solvent clean repair area.
- (10) Lay up outer repair plies according to the existing layer direction (refer to "Material Data Sheet" above). If the layer orientation is not clear please contact AQUILA Aviation GmbH.

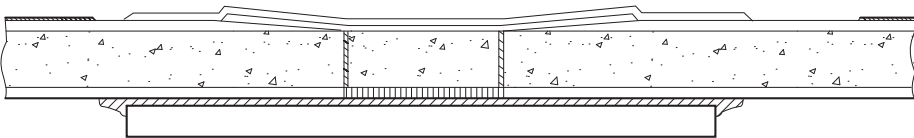

- (11) Pre-cure the repair at least 24 hours at 20°C (68°F) to 25°C (77°F).
- (12) Post-cure the repair at least 15 hours at 54°C (129°F) to 60°C (140°F).
- (13) Sand the repair surface down to contour.
- (14) Complete by scarfing and laminating opposite facing in a similar manner.
- (15) Refinish the repair area as described in "Exterior Finish" below.

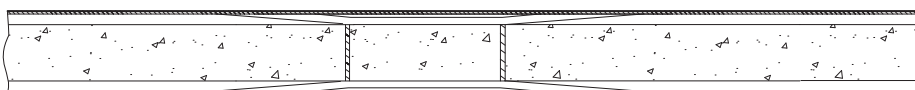

E Inner Laminate Repair (sandwich penetration, no access to inner side)

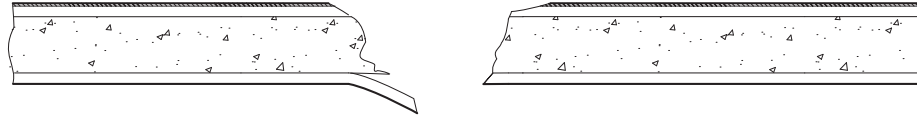

- (1) Remove surface finish from damaged area. Carefully examine the area around the damage. Check for disbonding between laminate layers and core material.
- (2) Remove damaged/loose outer laminate and core where no secure bond between core and laminate is suspected (circular or oval shaped hole). If necessary enlarge cut out to prepare an overlap in inner laminate of at least 20mm (0.8 inch). Check edge of damage for separation of core and inner laminate.
- (3) Scarf the edges of the external repair area with a grinding disk or block (refer to "Material Specifications" above for scarf size).

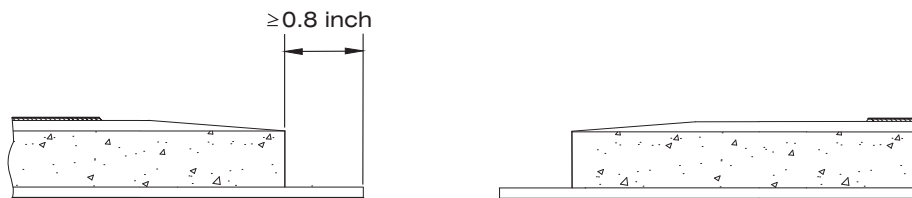

- (4) Solvent clean repair area.
- (5) Prepare a replacement core (refer to "Material Data Sheet" above) and fit it snugly in the trimmed shape. Leave a small amount of clearance for resin microballoon mixture.
- (6) Prepare the foam core for inserting in the repair:
 - (a) Apply a thin coat of resin to the foam core.
 - (b) Apply a coat of resin thickened with microballoons to the foam core.
 - (c) Laminate the inner layers onto the inner surface of the foam core. Make sure that layer orientation is correct (refer to "Material Data Sheet" above).
- (7) Apply a thin coat of resin to the repair area.
- (8) Put the foam core and inner laminate into position in the repair.

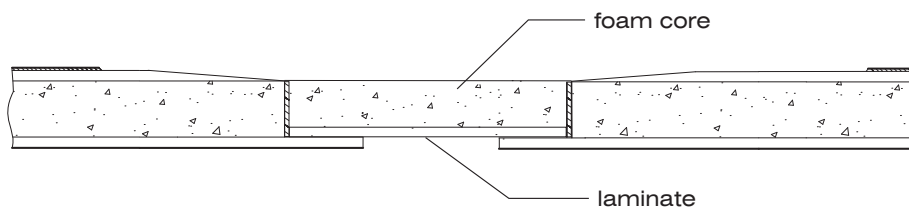

- (9) Pre-cure the repair at least 24 hours at 20°C (68°F) to 25°C (77°F).
- (10) Sand down the replacement core to contour.
- (11) Solvent clean repair area.
- (12) Apply a coat of resin thickened by microballoons to the foam core.
- (13) Apply a thin coat of resin to the scarfed edges of the repair area.
- (14) Lay up outer repair plies according to the existing layer direction (refer to "Material Data Sheet" above). If the layer orientation is not clear please contact AQUILA Aviation GmbH.

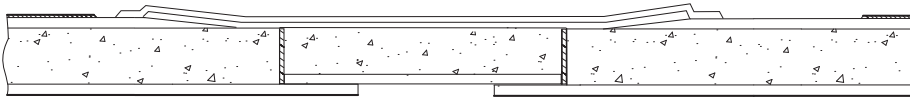

- (15) Pre-cure the repair at least 24 hours at 20°C (68°F) to 25°C (77°F).
- (16) Post-cure the repair at least 15 hours at 54°C (129°F) to 60°C (140°F).
- (17) Sand the repair surface down to contour.
- (18) Refinish the repair area as described in "Exterior Finish" below.

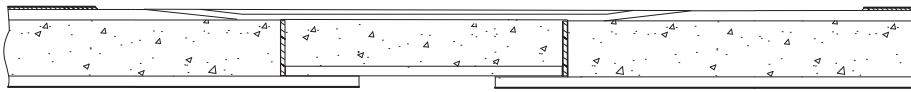

7. Repair of Monolithic Components

A. Monolithic Component Repair



- (1) Remove surface finish from damaged area. Carefully examine the area around the damage. Check for disbonding between laminate layers.
- (2) Scarf the edges of the repair area with a grinding disk or block (refer to "Material Specifications" above for scarf size).

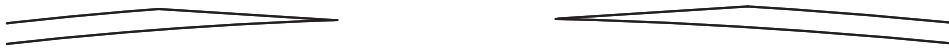

- (3) Solvent clean prepared area.
- (4) Lay up repair plies according to the existing layer direction (refer to "Material Data Sheet" above). If the layer orientation is not clear please contact AQUILA Aviation GmbH.

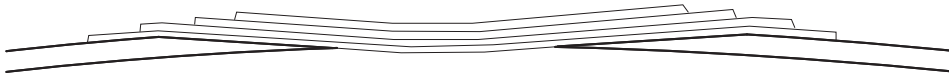

- (5) Pre-cure the repair at least 24 hours at 20°C (68°F) to 25°C (77°F).
- (6) Post-cure the repair at least 15 hours at 54°C (129°F) to 60°C (140°F).
- (7) Sand the repair surface down to contour.
- (8) Refinish the repair area as described in "Exterior Finish" below.

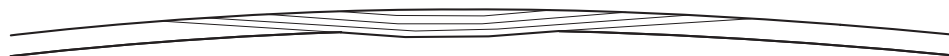

8. Exterior Finish

Prior painting over a repair, inspect the repair to ensure that it has hardened completely and has been properly contoured.

CAUTION: MASK OFF SURFACE AROUND REPAIR AREA THAT DOES NOT REQUIRE FILLING OR PAINT, PAY SPECIAL ATTENTION TO STATIC PORTS, ANTENNAS AND DRAIN HOLES.

A. Filler

NOTE: Filler should be used for repairing cosmetic blemishes and minor surface defects.

- (1) Sand the application area with 240 to 280-grit dry sandpaper.
- (2) Clean the application area with a suitable solvent.
- (3) Mix filler thoroughly in accordance with the manufacturer's instructions.
- (4) Apply filler with a clean applicator according to the manufacturer's instructions.
- (5) When the filler has hardened, lightly sand the repair area with 280-grit sandpaper and then switch for final sanding to 360-grit sandpaper to remove all sanding scratches.

B. Paint

- (1) Prepare the surface for paint by applying filler as required.
- (2) Clean the application area with a suitable solvent.
- (3) Visually inspect prepared surface for imperfections prior to painting.
- (4) Mix and apply paint as recommended by the manufacturer.

